

INJECTION MOULDED CASES. Peli Legendary Guarantee of Excellence: Peli Products, S.L.U. ("Peli") guarantees its injection moulded products for a lifetime* against breakage or defects in workmanship. Peli™ injection moulded cases are guaranteed to be watertight to a depth of 3.3 feet (1 meter) for 30 minutes (IP 67) if properly closed with undamaged o-ring in place unless otherwise stated. To the extent permitted by law, Peli's liability is limited to the case and not its contents or foam. All warranty claims of any nature are barred if the case has been altered, damaged or in any way physically changed, or subjected to abuse, misuse, negligence or accident.
 *Lifetime guarantee not applicable where prohibited by law. For complete warranty details, see: www.peli.com/en/warranty
 Lifetime Guarantee does not cover Roto Moulded cases, AALG products, fabric portion of backpacks or smart phone cover accessories.

ROTO MOULDED CASES. Peli 1 year limited warranty for Roto Moulded containers: Peli Products, S.L.U. ("Peli") warrants to the original purchaser of its rotationally moulded containers that its containers will be free of defects in materials and workmanship for a period of one year from the date of invoice. Such warranty does not cover any associated hardware including closure hardware, retractable handles, wheels, and fasteners, which Peli warrants against defects in materials and workmanship for a period of 90 days from the invoice date. To the extent permitted by law, Peli's liability is limited to the case and not its contents or foam. All warranty claims of any nature are barred if the container has been altered, damaged or in any way physically changed, or subjected to abuse, misuse, negligence or accident. For complete warranty details, see: www.peli.com/en/warranty

U.S.A.

U.S.A. & GLOBAL HEADQUARTERS
 23215 Early Avenue
 Torrance, CA 90505 USA
 Tel 310.326.4700
 800.473.5422 (Outside CA)
 Fax 310.326.3311

DEERFIELD
 PELI HARDIGG CASES
 USA HEADQUARTERS
 147 North Main Street
 South Deerfield, MA 01373
 Tel (800) 542-7344
 Fax (413) 665-8330
www.peli.com

EUROPE

FOR INFORMATION ON PELI LIGHTS, PELI CASES AND PELI STORM CASES IN EUROPE:

EUROPE, MIDDLE EAST & AFRICA HQ
 PELI PRODUCTS, S.L.U.
 C/ Provença, 388 Planta 7
 08025 • Barcelona, Spain
 Tel +34 934 674 999
 Fax +34 934 877 393
www.peli.com

FRANCE
 PELI PRODUITS FRANCE S.A.S.
 487 rue Léopold Le Hon
 01000 • Bourg en Bresse, France
 Tel +33 4 74 22 80 40
 Fax +33 4 74 22 09 34
www.peli.com

GERMANY
 PELI PRODUCTS GERMANY GmbH
 Graf-Adolf-Platz 15
 40213 • Düsseldorf, Germany
 Tel +49 (0) 211 882 42 401
 Fax +49 (0) 211 882 42 200
www.peli.com

UAE
 PELICAN PRODUCTS MIDDLE EAST
 JAFZA 13 office 032, P.O.Box 261008
 Jebel Ali - Dubai - United Arab Emirates
 Tel +971 (0)4 8876550
 Fax +971 (0)4 8876549

FOR INFORMATION ON PELI HARDIGG CASES IN EUROPE:

PELI-HARDIGG UK CASE CENTER
 Unit 4, Brookfield Industrial Estate
 Leacon Road
 Ashford Kent TN23 4TU
 United Kingdom
 Tel +44 (0) 1233 895895

PELI-HARDIGG FRANCE CASE CENTER
 20/22 Rue des Petits Hôtels
 75010 Paris, France
 Tel +33 (0)1 44 83 95 63

* We also have offices in Canada, Japan, China, Australia, South Korea and India.

CASES



CASES
CATALOGUE



©2015 Peli Products, S.L.U. All trademarks are registered and/or unregistered trademarks of Pelican Products, Inc., a U.S. corporation, its subsidiaries and/or affiliates. EU CODE: 0030-000-101E JAN 2015

Apple®, iPhone®, iPod®, iPad® and iPad Mini™ are registered trademarks of Apple Inc. Samsung Galaxy S® is a registered trademark of Samsung Electronics Co., Ltd. BlackBerry® is a registered trademark of Research In Motion Limited. Motorola is a registered trademark of Motorola, Inc. Nokia is a registered trademark of Nokia Corporation.

Follow us on

DISTRIBUTED BY:

MARKETS
SERVED:

FIRE MILITARY INDUSTRIAL LAW ENFORCEMENT OUTDOOR DIVE



Dear Customer,

Our continued global expansion is evidenced by the recent acquisition of the leading Australian manufacturer of rotationally moulded storage and transit cases, Trimcast, Pty. Ltd. This acquisition is an example that underscores our companywide commitment to bringing to market the widest variety of high-impact, protective case solutions in the world. As such, in the coming months, we will be rolling out several more new products, services and technologies. With market research and feedback from our customers, I'm confident that our new products will meet needs not met by any other case company.

Additional advancements include the increase in our standardised solution products, the Peli Roto Pack offering. You'll find this group under the Peli-Hardigg™ brand in the following pages. It includes an array of single lid cases, extra large shipping containers, rackmount cases for electronics, and specialty products such as the mobile field desk.

You'll also find within a focus on Advanced Case Solutions which leverages years of customisation experience and a business model that literally executes on the promise "Protecting All That You value". Peli-Hardigg Advanced Case Solutions Centers provide a high level of case, cushioning and protective solutions. These solutions include everything from layered foam cushioning to extremely complex metal work and mechanised enhancements.

With one call, you can bring the expertise of more than 70 engineers, manufacturing facilities (USA, Europe and Australia), and strategically located solution centers to any technical challenge or deadline you face.

Please take a moment to peruse the pages herein and let us know how we can support your protector case needs.

CONTENTS

1 Message from the President and CEO

PELI™ CASE

3-4 Anatomy of a Peli Case

5-8 Micro Cases

9-10 Laptop Cases

11-12 Small Cases

13-16 Medium Cases

17-22 Large Cases

23-24 Long Cases

25-26 Peli Organisation Solutions

27-29 Peli Case Specifications

30 Peli Case Accessories

PELI™ STORM CASE™

31-32 Anatomy of a Peli Storm Case

33-34 Small Cases

34 Laptop Cases

35-36 Medium Cases

37-40 Large Cases

41-42 Peli Storm Organisation Solutions

43-44 Peli Storm Case Specifications

PELI-HARDIGG™ ROTO PACK

45-46 Roto Pack - More Than A Box

47-48 Single Lid

49-50 Specialty Products

51-52 Rackmount

53-54 Miscellaneous Products / Global Locations

ULTIMATE EQUIPMENT PROTECTION



Since 1976 Peli Products has built a reputation for manufacturing the toughest Protector Case™ in the world. As a matter of fact, we invented the category. Over these years we've seen our cases used for some fairly crazy activities... and important ones, too.

Peli™ cases have been thrown out of helicopters in Iraq, floated through frigid fjords in Norway and rolled over by SUVs in Tanzania. With only a few

scratches to show on the outside, contents inside are left unscathed. These are minor details for major bragging rights. And that is really what it's all about. Getting your gear from point A to point B in the condition it's meant to be in: intact and functional. Because it might contain a large format camera that will shoot next month's magazine cover or a heart defibrillator that could save a person's life, you can't put a price on it.

ANATOMY OF A PELI™ CASE



STRONGER BY DESIGN

Peli™ cases are made with a proprietary combination of homo-polymers and co-polymers, using an open cell core and solid wall construction, which is stronger and lighter than a solid core wall. Stainless steel pins are used in hinges and handles.

A WATERTIGHT

The secret is the tongue and groove fit with a polymer o-ring acting as a waterproof seal.

B EASY ROLLER

Stainless steel ball bearing wheels last longer and ride smoother. The nylon hub adjacent to the stainless steel is made to resist heat. The result is less wear and tear on the polyurethane wheel.

C REINFORCED PADLOCK PROTECTORS

Stainless steel reinforced padlock protectors provide added strength and extra security against cutting and theft.

D DOUBLE-STEP LATCHES

The Double-Step latches are smarter and easier to open: it's the classic "C" clamp design with a secondary movement that works like a pry bar to start the release and offers plenty of leverage to open with a light pull.

E FOAM

All Peli™ cases with foam (except Micro Case Series™ cases, 1780W, 1780HL and 1780RF) come standard with Pick N Pluck™ foam. 1700, 1720, 1750 Cases come standard with 3 piece foam sets. Replacement foam is available for all models (except Memory Card Cases, i1010, i1030 and i 1015). To order a case with no foam, add NF to the catalogue number.

F NAMEPLATE

Custom engraved nameplates are available for a nominal fee.

G COOL UNDER PRESSURE

The Automatic Pressure Equalisation Valve releases built-up air pressure while keeping water molecules out, resulting in a watertight case that is even easier to open.

COLOURS



BLACK



DESERT TAN



ORANGE



SILVER



YELLOW



*OD GREEN

* OD green available upon request / Case contents not included

MICRO CASES

From small sensitive components and precision tools to portable MP3 players and smart phones. Protect your gear from the elements in a Micro Case Series™ case and eliminate the worries.

CASE | i1015 CASE

■ **INTERIOR DIMENSIONS:**
13.1 x 6.7 x 3.5 cm
(5.14" x 2.64" x 1.37")

■ **EXTERIOR DIMENSIONS:**
17 x 9.9 x 4.7 cm
(6.68" x 3.88" x 1.86")



0915 MEMORY CARD CASE



14.1 x 8.3 x 2.2 cm
(5.55" x 3.27" x 0.85")

12.2 x 5.7 x 1.4 cm
(4.79" x 2.25" x 0.55")

N/A

0.1 kg (.22 lbs.) WITH LINER



N/A

N/A

EXTERIOR DIMENSIONS

INTERIOR DIMENSIONS

LID/BOTTOM DEPTH

WEIGHT

COLOURS

AVAILABLE ACCESSORIES

CERTIFICATES

0945 MEMORY CARD CASE



14.1 x 8.3 x 2.2 cm
(5.55" x 3.27" x 0.85")

12.2 x 5.7 x 1.4 cm
(4.79" x 2.25" x 0.55")

N/A

0.1 kg (.21 lbs.) WITH LINER



N/A

N/A

EXTERIOR DIMENSIONS

INTERIOR DIMENSIONS

LID/BOTTOM DEPTH

WEIGHT

COLOURS

AVAILABLE ACCESSORIES

CERTIFICATES

0955 SPORT WALLET



14.1 x 8.3 x 2.2 cm
5.55" x 3.27" x 0.85"

12.2 x 5.7 x 1.4 cm
4.79" x 2.25" x 0.55"

N/A

0.1 kg (0.22 lbs.)



N/A

N/A

EXTERIOR DIMENSIONS

INTERIOR DIMENSIONS

LID/BOTTOM DEPTH

WEIGHT

COLOURS

AVAILABLE ACCESSORIES

CERTIFICATES



1010 MICRO CASE



14.9 x 10.3 x 5.4 cm
(5.88" x 4.06" x 2.12")

11.1 x 7.3 x 4.3 cm
(4.37" x 2.87" x 1.68")

1.8 cm / 2.4 cm
(0.69" / 0.94")

0.19 kg (0.41 lbs.) WITH FOAM
0.18 kg (0.4 lbs.) NO FOAM



Pick N Pluck™ foam insert

IP67

i1010 MICRO CASE



External headphone jack
lets you listen to your
player, while case is closed

14.9 x 10.3 x 5.4 cm
(5.88" x 4.06" x 2.12")

11.1 x 7.3 x 4.3 cm
(4.37" x 2.87" x 1.68")

1.8 cm / 2.4 cm
(0.69" / 0.94")

0.19 kg (0.41 lbs.)



N/A

N/A



Photo by Arnaud Thomas

1015 MICRO CASE

EXTERIOR DIMENSIONS	17 x 9.9 x 4.7 cm (6.68" x 3.88" x 1.86")
INTERIOR DIMENSIONS	13.1 x 6.7 x 3.5 cm (5.14" x 2.64" x 1.37")
LID/BOTTOM DEPTH	1.1 cm / 2.4 cm (0.43" / 0.94")
WEIGHT	0.21 kg (0.46 lbs.)
COLOURS	
AVAILABLE ACCESSORIES	N/A
CERTIFICATES	N/A

11015 CASE

EXTERIOR DIMENSIONS	17 x 9.9 x 4.7 cm (6.68" x 3.88" x 1.86")
INTERIOR DIMENSIONS	13.1 x 6.7 x 3.5 cm (5.14" x 2.64" x 1.37")
LID/BOTTOM DEPTH	1.1 cm / 2.4 cm (0.43" / 0.94")
WEIGHT	0.22 kg (0.49 lbs.)
COLOURS	
AVAILABLE ACCESSORIES	N/A
CERTIFICATES	N/A

External headphone jack lets you listen to your player, while case is closed.

FITS MODELS: iPhone® • BlackBerry® Curve/Storm/Pearl/Bold/T-Mobile® G1/ MyTouch 3G • Motorola Droid/Clig/Nokia 5800/5530/N97 Mini/E63/E71/E71x/E75/N79/N78

1020 MICRO CASE

EXTERIOR DIMENSIONS	17.3 x 12.1 x 5.4 cm (6.82" x 4.75" x 2.12")
INTERIOR DIMENSIONS	13.5 x 9 x 4.3 cm (5.31" x 3.56" x 1.68")
LID/BOTTOM DEPTH	1.8 cm / 2.4 cm (0.69" / 0.94")
WEIGHT	0.25 kg (0.56 lbs.) WITH FOAM 0.25 kg (0.55 lbs.) NO FOAM
COLOURS	
AVAILABLE ACCESSORIES	Pick N Pluck™ foam insert
CERTIFICATES	IP67

1030 MICRO CASE

EXTERIOR DIMENSIONS	19 x 9.8 x 6.2 cm (7.50" x 3.87" x 2.43")
INTERIOR DIMENSIONS	16.2 x 6.7 x 5.2 cm (6.37" x 2.62" x 2.06")
LID/BOTTOM DEPTH	1.8 cm / 3.2 cm (0.69" / 1.25")
WEIGHT	0.28 kg (0.61 lbs.) WITH FOAM 0.27 kg (0.6 lbs.) NO FOAM
COLOURS	
AVAILABLE ACCESSORIES	Pick N Pluck™ foam insert
CERTIFICATES	IP67

1040 MICRO CASE

EXTERIOR DIMENSIONS	19 x 12.8 x 5.4 cm (7.50" x 5.06" x 2.12")
INTERIOR DIMENSIONS	16.5 x 9.8 x 4.4 cm (6.50" x 3.87" x 1.75")
LID/BOTTOM DEPTH	1.8 cm / 2.4 cm (0.69" / 0.94")
WEIGHT	0.32 kg (0.71 lbs.) WITH FOAM 0.32 kg (0.7 lbs.) NO FOAM
COLOURS	
AVAILABLE ACCESSORIES	Pick N Pluck™ foam insert
CERTIFICATES	IP67

1050 MICRO CASE

EXTERIOR DIMENSIONS	19 x 12.8 x 7.9 cm (7.50" x 5.06" x 3.12")
INTERIOR DIMENSIONS	16 x 9.3 x 7 cm (6.31" x 3.68" x 2.75")
LID/BOTTOM DEPTH	1.8 cm / 4.9 cm (0.69" / 1.94")
WEIGHT	0.38 kg (0.83 lbs.) WITH FOAM 0.37 kg (0.81 lbs.) NO FOAM
COLOURS	
AVAILABLE ACCESSORIES	Pick N Pluck™ foam insert
CERTIFICATES	IP67

1060 MICRO CASE

EXTERIOR DIMENSIONS	23.8 x 14.1 x 6.7 cm (9.37" x 5.56" x 2.62")
INTERIOR DIMENSIONS	20.9 x 10.8 x 5.7 cm (8.25" x 4.25" x 2.25")
LID/BOTTOM DEPTH	1.8 cm / 3.7 cm (0.69" / 1.44")
WEIGHT	0.47 kg (1.03 lbs.) WITH FOAM 0.45 kg (1 lbs.) NO FOAM
COLOURS	
AVAILABLE ACCESSORIES	Pick N Pluck™ foam insert
CERTIFICATES	IP67



See product on page 6

Case contents not included

LAPTOP CASES



Mobility and protection in one. Pelic's laptop cases accommodate netbooks and laptops up to 17 inches. Selected models have ample room and compartments for accessories and peripherals.

EXTERIOR DIMENSIONS
INTERIOR DIMENSIONS
LID/BOTTOM DEPTH
WEIGHT
COLOURS
AVAILABLE ACCESSORIES
CERTIFICATES

1470 CASE



50.4 x 35.4 x 11.9 cm (19.87" x 13.93" x 4.68")
45.1 x 28.9 x 10.5 cm (17.75" x 11.37" x 4.12")
3.8 cm / 6 cm (1.50" / 2.37")
2.5 kg (5.51 lbs.) WITH FOAM 1.94 kg (4.28 lbs.) NO FOAM
■
Panel frame, 3 pc. replacement foam set, shoulder strap
MIL C-4150J

1490 CASE



50.4 x 35.4 x 11.9 cm (19.87" x 13.93" x 4.68")
45.1 x 28.9 x 10.5 cm (17.75" x 11.37" x 4.12")
3.8 cm / 6.7 cm (1.50" / 2.62")
2.95 kg (6.5 lbs.) WITH FOAM 2.48 kg (5.47 lbs.) NO FOAM
■
Panel frame, 3 pc. foam set, shoulder strap, computer lid organiser, computer bottom insert
DEF STAN 81-41/STANAG 4280

EXTERIOR DIMENSIONS
INTERIOR DIMENSIONS
LID/BOTTOM DEPTH
WEIGHT
COLOURS
AVAILABLE ACCESSORIES
CERTIFICATES

1495 CASE



54.9 x 43.8 x 12.4 cm (21.62" x 17.25" x 4.87")
47.9 x 33.3 x 9.7 cm (18.87" x 13.12" x 3.81")
2.8 cm / 6.8 cm (1.12" / 2.68")
3.8 kg (8.37 lbs.) WITH FOAM 3.28 kg (7.23 lbs.) NO FOAM
■ **
3 pc. foam set, shoulder strap
IP67 DEF STAN 81-41/STANAG 4280

1490CC1 CASE



50.4 x 35.4 x 11.9 cm (19.87" x 13.93" x 4.68")
45.1 x 28.9 x 10.5 cm (17.75" x 11.37" x 4.12")
3.8 cm / 6.7 cm (1.50" / 2.62")
2.95 kg (6.5 lbs.) WITH FOAM 2.48 kg (5.47 lbs.) NO FOAM
■
Computer lid organiser, computer bottom insert
DEF STAN 81-41/STANAG 4280

EXTERIOR DIMENSIONS
INTERIOR DIMENSIONS
LID/BOTTOM DEPTH
WEIGHT
COLOURS
AVAILABLE ACCESSORIES
CERTIFICATES

1495CC1 CASE



54.9 x 43.8 x 12.4 cm (21.62" x 17.25" x 4.87")
47.9 x 33.3 x 9.7 cm (18.87" x 13.12" x 3.81")
2.8 cm / 6.8 cm (1.12" / 2.68")
5.03 kg (11.1 lbs.)
■ **
Attache/computer lid insert, 4 lb. high density foam
IP67 DEF STAN 81-41/STANAG 4280

1490CC2 CASE



50.4 x 35.4 x 11.9 cm (19.87" x 13.93" x 4.68")
45.1 x 28.9 x 10.5 cm (17.75" x 11.37" x 4.12")
3.8 cm / 6.7 cm (1.50" / 2.62")
2.95 kg (6.5 lbs.) WITH FOAM 2.48 kg (5.47 lbs.) NO FOAM
■
2 pc. high density foam, computer lid organiser
DEF STAN 81-41/STANAG 4280

EXTERIOR DIMENSIONS
INTERIOR DIMENSIONS
LID/BOTTOM DEPTH
WEIGHT
COLOURS
AVAILABLE ACCESSORIES
CERTIFICATES

1495CC2 CASE



54.9 x 43.8 x 12.4 cm (21.62" x 17.25" x 4.87")
47.9 x 33.3 x 9.7 cm (18.87" x 13.12" x 3.81")
2.8 cm / 6.8 cm (1.12" / 2.68")
4.08 kg (8.99 lbs.)
■ **
Attache/computer lid insert, 4 lb. high density foam
IP67 DEF STAN 81-41/STANAG 4280

SMALL CASES

Lightweight but extremely strong; compact yet fully capable. Perfect for valuable gear like hand tools and small to medium electronic components, handheld GPS systems, and DSLR cameras.



1120 CASE

UPDATED MODEL



21.4 x 17.2 x 9.8 cm (8.41" x 6.76" x 3.87")
18.9 x 12.6 x 8.5 cm (7.46" x 4.96" x 3.33")
1.3 cm / 6.5 cm (0.50" / 2.56")
0.65 kg (1.43 lbs.) WITH FOAM 0.61 kg (1.34 lbs.) NO FOAM
■ ■ ■
Panel frame, 3 pc. replacement foam set
IP67 DEF STAN 81-41/STANAG 4280

EXTERIOR DIMENSIONS
INTERIOR DIMENSIONS
LID/BOTTOM DEPTH
WEIGHT
COLOURS
AVAILABLE ACCESSORIES
CERTIFICATES

1200 CASE



27 x 24.6 x 12.4 cm (10.62" x 9.68" x 4.87")
23.5 x 18.1 x 10.5 cm (9.25" x 7.12" x 4.12")
3 cm / 7.4 cm (1.18" / 2.93")
1.3 kg (2.87 lbs.) WITH FOAM 1.2 kg (2.65 lbs.) NO FOAM
■ ■ ■ ■ *
Panel frame, 3 pc. replacement foam set
IP67 DEF STAN 81-41/STANAG 4280

EXTERIOR DIMENSIONS
INTERIOR DIMENSIONS
LID/BOTTOM DEPTH
WEIGHT
COLOURS
AVAILABLE ACCESSORIES
CERTIFICATES

1150 CASE

UPDATED MODEL



24 x 19.8 x 10.9 cm (9.44" x 7.8" x 4.29")
21.6 x 15.2 x 9.5 cm (8.49" x 5.99" x 3.75")
1.9 cm / 7.3 cm (0.75" / 2.87")
0.79 kg (1.75 lbs.) WITH FOAM 0.73 kg (1.61 lbs.) NO FOAM
■ ■ ■
Panel frame, 3 pc. replacement foam set
IP67 DEF STAN 81-41/STANAG 4280

EXTERIOR DIMENSIONS
INTERIOR DIMENSIONS
LID/BOTTOM DEPTH
WEIGHT
COLOURS
AVAILABLE ACCESSORIES
CERTIFICATES

1300 CASE



27 x 24.6 x 17.4 cm (10.62" x 9.68" x 6.87")
25.1 x 17.8 x 15.5 cm (9.87" x 7.00" x 6.12")
3 cm / 12.5 cm (1.18" / 4.93")
1.6 kg (3.53 lbs.) WITH FOAM 1.4 kg (3.09 lbs.) NO FOAM
■ ■ ■ ■ *
Panel frame, 3 pc. replacement foam set
IP67 DEF STAN 81-41/STANAG 4280

EXTERIOR DIMENSIONS
INTERIOR DIMENSIONS
LID/BOTTOM DEPTH
WEIGHT
COLOURS
AVAILABLE ACCESSORIES
CERTIFICATES

1170 CASE



29.6 x 21.2 x 9.6 cm (11.64" x 8.34" x 3.78")
26.8 x 15.3 x 8 cm (10.54" x 6.04" x 3.16")
2.7 cm / 5.3 cm (1.08" / 2.08")
0.95 kg (2.10 lbs.) WITH FOAM 0.89 kg (1.96 lbs.) NO FOAM
■ ■ ■ ■ **
3 pc. replacement foam set
N/A

EXTERIOR DIMENSIONS
INTERIOR DIMENSIONS
LID/BOTTOM DEPTH
WEIGHT
COLOURS
AVAILABLE ACCESSORIES
CERTIFICATES

1400 CASE



33.9 x 29.5 x 15.2 cm (13.37" x 11.62" x 6.00")
30 x 22.5 x 13.2 cm (11.81" x 8.87" x 5.18")
3 cm / 10.2 cm (1.18" / 4.00")
2 kg (4.41 lbs.) WITH FOAM 1.8 kg (3.97 lbs.) NO FOAM
■ ■ ■ ■ ■ ■
Panel frame, 3 pc. replacement foam set
IP67 • MIL C-4150J • DEF STAN 81-41/STANAG 4280 • ATA 300

EXTERIOR DIMENSIONS
INTERIOR DIMENSIONS
LID/BOTTOM DEPTH
WEIGHT
COLOURS
AVAILABLE ACCESSORIES
CERTIFICATES

Case contents not included | * = ■ : Available upon minimum quantities | ** = ■ ■ and ■ : Available upon minimum quantities

MEDIUM CASES



Still mobile with a little more room for protecting slightly larger gear or multiple instruments and accessories. Interior options are available for extra protection. Select models meet carry-on luggage specifications.

1430 TOP LOADER CASE



43 x 24.4 x 34.1 cm
(16.93" x 9.61" x 13.42")
34.4 x 14.6 x 29.7 cm
(13.56" x 5.76" x 11.70")
5.1 cm / 24.6 cm
(2.00" / 9.70")
2.95 kg (6.5 lbs.) WITH FOAM
2.54 kg (5.6 lbs.) NO FOAM

■ **

Panel frame, 5 pc. foam set, strap kit, padded divider set, office divider kit, boat bracket kit, lid organiser

IP67
DEF STAN 81-41/STANAG 4280

EXTERIOR DIMENSIONS

INTERIOR DIMENSIONS

LID/BOTTOM DEPTH

WEIGHT

COLOURS

AVAILABLE ACCESSORIES

CERTIFICATES

1460 CASE



52.9 x 32.3 x 32.4 cm
(20.85" x 12.73" x 12.75")
47.1 x 25.2 x 27.7 cm
(18.54" x 9.92" x 10.92")
12.5 cm / 15.3 cm
(4.91" / 6.01")
5.66 kg (12.48 lbs.) WITH FOAM
3.97 kg (8.75 lbs.) NO FOAM

■ ■ *

Replacement Foam Set

N/A

1460EMS CASE



52.9 x 32.3 x 32.4 cm
(20.85" x 12.73" x 12.75")
47.1 x 25.2 x 27.7 cm
(18.54" x 9.92" x 10.92")
12.5 cm / 15.3 cm
(4.91" / 6.01")
8.26 kg (18.2 lbs.)
WITH TRAY ASSEMBLY

■ ■

Tray system

N/A

1440 TOP LOADER CASE



50 x 30.5 x 45.7 cm
(19.70" x 12.00" x 18.00")
43.4 x 19 x 40.6 cm
(17.10" x 7.50" x 16.00")
5.1 cm / 35.5 cm
(2.00" / 14.00")
7.48 kg (16.5 lbs.) WITH FOAM
6.58 kg (14.5 lbs.) NO FOAM

■ **

6 pc. foam set, utility padded divider set and lid organiser, office divider set and lid organiser

IP67
DEF STAN 81-41/STANAG 4280

EXTERIOR DIMENSIONS

INTERIOR DIMENSIONS

LID/BOTTOM DEPTH

WEIGHT

COLOURS

AVAILABLE ACCESSORIES

CERTIFICATES

1450 CASE

Similarly sized Pelic Storm Case: iM2200



40.6 x 33 x 17.4 cm
(16.00" x 13.00" x 6.87")
37.1 x 25.8 x 15.2 cm
(14.62" x 10.18" x 6.00")
4.4 cm / 10.8 cm
(1.75" / 4.25")

2.9 kg (6.39 lbs.) WITH FOAM
2.5 kg (5.51 lbs.) NO FOAM

■ ■ ■ ■ ■ ■

Panel frame, 3 pc. replacement foam set, padded divider set

IP67 • MIL C-4150J
DEF STAN 81-41/STANAG 4280

EXTERIOR DIMENSIONS

INTERIOR DIMENSIONS

LID/BOTTOM DEPTH

WEIGHT

COLOURS

AVAILABLE ACCESSORIES

CERTIFICATES

1460TOOL CASE



52.9 x 32.3 x 32.4 cm
(20.85" x 12.73" x 12.75")
47.1 x 25.2 x 27.7 cm
(18.54" x 9.92" x 10.92")
12.5 cm / 15.3 cm
(4.91" / 6.01")

5.9 kg (13 lbs.)
WITH TRAY ASSEMBLY

■ ■ ■

N/A

N/A



Photo by Marek Arcimowicz

1500 CASE Similarly sized Peli Storm Case: iM230047 x 35.7 x 17.6 cm
(18.50" x 14.06" x 6.93")42.5 x 28.4 x 15.5 cm
(16.75" x 11.18" x 6.12")4.6 cm / 10.9 cm
(1.81" / 4.31")3.2 kg (7.05 lbs.) WITH FOAM
2.9 kg (6.39 lbs.) NO FOAM

Panel frame, 3 pc. replacement foam set, padded divider set, Photo lid organiser, standard lid organiser, EMS Kit

IP67 • MIL C-4150J • DEF STAN 81-41/STANAG 4280 • ATA 300

EXTERIOR DIMENSIONS**INTERIOR DIMENSIONS****LID/BOTTOM DEPTH****WEIGHT****COLOURS****AVAILABLE ACCESSORIES****CERTIFICATES****1510 CARRY ON CASE** Similarly sized Peli Storm Case: iM250055.9 x 35.1 x 22.9 cm
(22.00" x 13.81" x 9.00")50.1 x 27.9 x 19.3 cm
(19.75" x 11.00" x 7.60")4.5 cm / 14.7 cm
(1.79" / 5.79")6.17 kg (13.6 lbs.) WITH FOAM
5.44 kg (11.99 lbs.) NO FOAM

4 pc. replacement foam set, padded divider set, lid organiser

IP67
DEF STAN 81-41/STANAG 4280

Case contents not included

1510LOC CASE Similarly sized Peli Storm Case: iM2500

With computer sleeve and accessories pouch

55.9 x 35.1 x 22.9 cm
(22.00" x 13.81" x 9.00")50.1 x 27.9 x 19.3 cm
(19.75" x 11.00" x 7.60")4.5 cm / 14.7 cm
(1.79" / 5.79")

6.17 kg (13.6 lbs.)



N/A

IP67
DEF STAN 81-41/STANAG 4280**EXTERIOR DIMENSIONS****INTERIOR DIMENSIONS****LID/BOTTOM DEPTH****WEIGHT****COLOURS****AVAILABLE ACCESSORIES****CERTIFICATES****1510M MOBILITY CASE**59.8 x 36.5 x 27 cm
(23.55" x 14.36" x 10.62")50.1 x 27.9 x 19.3 cm
(19.75" x 11.00" x 7.60")4.5 cm / 14.7 cm
(1.79" / 5.79")

7.39 kg (16.3 lbs.) NO FOAM



4 pc. replacement Foam set, padded divider set only, lid organizer

IP54

1510SC CASE

With padded dividers and lid organiser

55.9 x 35.1 x 22.9 cm
(22.00" x 13.81" x 9.00")50.1 x 27.9 x 19.3 cm
(19.75" x 11.00" x 7.60")4.5 cm / 14.7 cm
(1.79" / 5.79")

6.17 kg (13.6 lbs.)



N/A

IP67
DEF STAN 81-41/STANAG 4280**EXTERIOR DIMENSIONS****INTERIOR DIMENSIONS****LID/BOTTOM DEPTH****WEIGHT****COLOURS****AVAILABLE ACCESSORIES****CERTIFICATES****1520 CASE** Similarly sized Peli Storm Case: iM240048.5 x 39.2 x 19.2 cm
(19.12" x 15.43" x 7.56")45.4 x 32.4 x 17.1 cm
(17.87" x 12.75" x 6.75")4.6 cm / 12.5 cm
(1.81" / 4.93")4.24 kg (9.35 lbs.) WITH FOAM
3.76 kg (8.29 lbs.) NO FOAM

Panel frame, 3 pc. foam set, padded divider set, Photo lid organiser, standard lid organiser, convertible travel bag

IP67 • MIL C-4150J
DEF STAN 81-41/STANAG 4280**1510LFC CASE**

With lid organiser

55.9 x 35.1 x 22.9 cm
(22.00" x 13.81" x 9.00")50.1 x 27.9 x 19.3 cm
(19.75" x 11.00" x 7.60")4.5 cm / 14.7 cm
(1.79" / 5.79")

6.17 kg (13.6 lbs.)



N/A

IP67
DEF STAN 81-41/STANAG 4280**EXTERIOR DIMENSIONS****INTERIOR DIMENSIONS****LID/BOTTOM DEPTH****WEIGHT****COLOURS****AVAILABLE ACCESSORIES****CERTIFICATES****1550 CASE** Similarly sized Peli Storm Case: iM260052.4 x 42.8 x 20.6 cm
(20.62" x 16.87" x 8.12")46.8 x 35.5 x 19.3 cm
(18.43" x 14.00" x 7.62")4.4 cm / 14.9 cm
(1.75" / 5.87")5.4 kg (11.9 lbs.) WITH FOAM
4.8 kg (10.58 lbs.) NO FOAM

Panel frame, 4 pc foam set, Pick N Pluck™ foam only, padded divider set, EMS Kit

IP67 • MIL C-4150J • DEF STAN 81-41/STANAG 4280 • ATA 300

Case contents not included

LARGE CASES



Designed for extreme protection during transport and storage. Customisable interiors allow for extra protection and inventory control. Select models feature retractable handles, extra wide grips, and sturdy casters for efficient mobility.

1560 CASE



56 x 45.5 x 26.5 cm (22.06" x 17.93" x 10.43")
51.7 x 39.2 x 22.9 cm (20.37" x 15.43" x 9.00")
5.1 cm / 17.8 cm (2.00" / 7.00")
9.07 kg (20 lbs.) WITH FOAM 7.71 kg (17 lbs.) NO FOAM
■ **
4 pc. foam set, Pick N Pluck™ foam only, padded divider set, lid organiser
IP67 DEF STAN 81-41/STANAG 4280

EXTERIOR DIMENSIONS
INTERIOR DIMENSIONS
LID/BOTTOM DEPTH
WEIGHT
COLOURS
AVAILABLE ACCESSORIES
CERTIFICATES

1560LFC with lid organiser



56 x 45.5 x 26.5 cm (22.06" x 17.93" x 10.43")
51.7 x 39.2 x 22.9 cm (20.37" x 15.43" x 9.00")
5.1 cm / 17.8 cm (2.00" / 7.00")
9.07 kg (20 lbs.) WITH FOAM 7.71 kg (17 lbs.) NO FOAM
■
N/A
IP67 DEF STAN 81-41/STANAG 4280

1560LOC with computer sleeve and accessories pouch



56 x 45.5 x 26.5 cm (22.06" x 17.93" x 10.43")
51.7 x 39.2 x 22.9 cm (20.37" x 15.43" x 9.00")
5.1 cm / 17.8 cm (2.00" / 7.00")
9.07 kg (20 lbs.) WITH FOAM 7.71 kg (17 lbs.) NO FOAM
■
N/A
IP67 DEF STAN 81-41/STANAG 4280

EXTERIOR DIMENSIONS
INTERIOR DIMENSIONS
LID/BOTTOM DEPTH
WEIGHT
COLOURS
AVAILABLE ACCESSORIES
CERTIFICATES

1560M MOBILITY CASE



60.4 x 46.5 x 30.7 cm (23.78" x 18.33" x 12.08")
51.7 x 39.2 x 22.9 cm (20.37" x 15.43" x 9.00")
5.1 cm / 17.8 cm (2.00" / 7.00")
9.66 kg (21.3 lbs) NO FOAM
■
4 pc. replacement foam set, Pick N Pluck™ Sections Only (set of 2), padded divider set only, lid organizer
IP54

1560SC with padded dividers and lid organiser



56 x 45.5 x 26.5 cm (22.06" x 17.93" x 10.43")
51.7 x 39.2 x 22.9 cm (20.37" x 15.43" x 9.00")
5.1 cm / 17.8 cm (2.00" / 7.00")
9.07 kg (20 lbs.) WITH FOAM 7.71 kg (17 lbs.) NO FOAM
■
N/A
IP67 DEF STAN 81-41/STANAG 4280

EXTERIOR DIMENSIONS
INTERIOR DIMENSIONS
LID/BOTTOM DEPTH
WEIGHT
COLOURS
AVAILABLE ACCESSORIES
CERTIFICATES

1600 CASE Similarly sized Pelic Storm Case: iM2700



61.6 x 49.3 x 22 cm (24.25" x 19.43" x 8.68")
54.4 x 41.9 x 20 cm (21.43" x 16.50" x 7.87")
4.4 cm / 15.5 cm (1.75" / 6.12")
6.4 kg (14.11 lbs.) WITH FOAM 5.9 kg (13 lbs.) NO FOAM
■ ■ ■ ■ ■ ■
4 pc. foam set, Pick N Pluck™ foam only, padded divider set, lid organiser
IP67 • MIL C-4150J • DEF STAN 81-41/STANAG 4280 • ATA 300

1610 CASE Similarly sized Peli Storm Case: iM2720



EXTERIOR DIMENSIONS
62.7 x 49.7 x 30.3 cm
(24.71" x 19.58" x 11.93")

INTERIOR DIMENSIONS
55 x 42.2 x 26.8 cm
(21.68" x 16.62" x 10.56")

LID/BOTTOM DEPTH
5.2 cm / 21.6 cm
(2.06" / 8.50")

WEIGHT
10.2 kg (22.49 lbs.) WITH FOAM
9.07 kg (20 lbs.) NO FOAM

COLOURS
■ **

AVAILABLE ACCESSORIES
5 pc. foam set, padded divider set, lid organiser

CERTIFICATES
IP67
DEF STAN 81-41/STANAG 4280

1610M MOBILITY CASE



EXTERIOR DIMENSIONS
66.5 x 58.4 x 34.7 cm
(26.20" x 23.00" x 13.68")

INTERIOR DIMENSIONS
55.3 x 42.4 x 27 cm
(21.78" x 16.69" x 10.62")

LID/BOTTOM DEPTH
5.2 cm / 21.8 cm
(2.05" / 8.57")

WEIGHT
11.93 kg (26.3 lbs) NO FOAM

COLOURS
■

AVAILABLE ACCESSORIES
Lid organizer, 5 pc. replacement foam set, Pick N Pluck™ sections only (set of 3), padded divider set only

CERTIFICATES
IP54

1620 CASE Similarly sized Peli Storm Case: iM2750



EXTERIOR DIMENSIONS
63 x 49.2 x 35.2 cm
(24.81" x 19.37" x 13.87")

INTERIOR DIMENSIONS
54.3 x 41.4 x 31.9 cm
(21.37" x 16.31" x 12.56")

LID/BOTTOM DEPTH
5.2 cm / 26.7 cm
(2.06" / 10.50")

WEIGHT
11.8 kg (26.01 lbs.) WITH FOAM
11.1 kg (24.47 lbs.) NO FOAM

COLOURS
■ **

AVAILABLE ACCESSORIES
6 pc. foam set, padded divider set, lid organiser

CERTIFICATES
IP67 • MIL C-4150J
DEF STAN 81-41/STANAG 4280

1620M MOBILITY CASE



EXTERIOR DIMENSIONS
66.5 x 58.4 x 39.6 cm
(26.20" x 23.00" x 15.61")

INTERIOR DIMENSIONS
54.5 x 41.7 x 31.8 cm
(21.48" x 16.42" x 12.54")

LID/BOTTOM DEPTH
5.1 cm / 26.7 cm
(2.01" / 10.53")

WEIGHT
12.7 kg (28 lbs) NO FOAM

COLOURS
■

AVAILABLE ACCESSORIES
Lid organizer, 6 pc. replacement foam set, Pick N Pluck™ sections only (set of 4), replacement O-ring, padded divider set only

CERTIFICATES
IP54

1630 TRANSPORT CASE



EXTERIOR DIMENSIONS
79.4 x 61.5 x 44.4 cm
(31.28" x 24.21" x 17.48")

INTERIOR DIMENSIONS
70.3 x 53.3 x 39.4 cm
(27.70" x 20.98" x 15.50")

LID/BOTTOM DEPTH
8.3 cm / 30.8 cm
(3.25" / 12.14")

WEIGHT
16.33 kg (36 lbs.) WITH FOAM
14.06 kg (31 lbs.) NO FOAM

COLOURS
■ **

AVAILABLE ACCESSORIES
5 pc. foam set, padded divider set, lid organiser Document Container Accessory

CERTIFICATES
IP67
DEF STAN 81-41/STANAG 4280

1640 TRANSPORT CASE



EXTERIOR DIMENSIONS
69.1 x 69.8 x 41.4 cm
(27.20" x 27.50" x 16.30")

INTERIOR DIMENSIONS
60.2 x 60.9 x 35.3 cm
(23.70" x 24.00" x 13.90")

LID/BOTTOM DEPTH
5.1 cm / 30.2 cm
(2.00" / 11.90")

WEIGHT
17.24 kg (38 lbs.) WITH FOAM
15.42 kg (34 lbs.) NO FOAM

COLOURS
■ **

AVAILABLE ACCESSORIES
5 pc. foam set, padded divider set, lid organiser

CERTIFICATES
IP67
DEF STAN 81-41/STANAG 4280

1650 CASE Similarly sized Peli Storm Case: iM2950



EXTERIOR DIMENSIONS
80.2 x 52 x 31.6 cm
(31.59" x 20.47" x 12.45")

INTERIOR DIMENSIONS
72.5 x 44.5 x 27 cm
(28.57" x 17.52" x 10.65")

LID/BOTTOM DEPTH
4.6 cm / 22.4 cm
(1.81" / 8.84")

WEIGHT
12.73 kg (28.06 lbs.) WITH FOAM
10.9 kg (24.03 lbs.) NO FOAM

COLOURS
■ **

AVAILABLE ACCESSORIES
4 pc. foam set, padded divider set, photo lid organiser

CERTIFICATES
IP67 • MIL C-4150J • DEF STAN 81-41/STANAG 4280 • ATA 300

1660 CASE



EXTERIOR DIMENSIONS
80 x 58.1 x 48.2 cm
(31.50" x 22.87" x 19.00")

INTERIOR DIMENSIONS
71.5 x 50.1 x 44.7 cm
(28.18" x 19.75" x 17.62")

LID/BOTTOM DEPTH
8.9 cm / 35.9 cm
(3.50" / 14.12")

WEIGHT
19.1 kg (42.11 lbs.) WITH FOAM
15.5 kg (34.17 lbs.) NO FOAM

COLOURS
■ **

AVAILABLE ACCESSORIES
5 pc. foam set, padded divider set, photo lid organiser

CERTIFICATES
IP67
DEF STAN 81-41/STANAG 4280

1690 TRANSPORT CASE



EXTERIOR DIMENSIONS
84.7 x 72.2 x 46.3 cm
(33.36" x 28.44" x 18.23")

INTERIOR DIMENSIONS
76.2 x 63.5 x 38.1 cm
(30.01" x 25.02" x 15.00")

LID/BOTTOM DEPTH
7.3 cm / 30.8 cm
(2.86" / 12.14")

WEIGHT
19.5 kg (43 lbs.) WITH FOAM
15.42 kg (34 lbs.) NO FOAM

COLOURS
■ **

AVAILABLE ACCESSORIES
5 pc. foam set, padded divider set, lid organiser

CERTIFICATES
IP67
DEF STAN 81-41/STANAG 4280

Case contents not included | ** = ■ and □ : Available upon minimum quantities

Case contents not included | ** = ■ and □ : Available upon minimum quantities





See product on page 19

1730 TRANSPORT CASE

	95.2 x 68.9 x 36.5 cm (37.50" x 27.13" x 14.37")
	86.3 x 60.9 x 31.7 cm (34.00" x 24.00" x 12.50")
	6.3 cm / 25.4 cm (2.50" / 10.00")
	17.24 kg (38 lbs.) WITH FOAM 13.61 kg (30 lbs.) NO FOAM
	■ **
	5 pc. replacement foam set
IP67	

EXTERIOR DIMENSIONS
INTERIOR DIMENSIONS
LID/BOTTOM DEPTH
WEIGHT
COLOURS
AVAILABLE ACCESSORIES
CERTIFICATES

1780 TRANSPORT CASE

	114 x 64.3 x 41.9 cm (44.90" x 25.32" x 16.50")
	106.6 x 55.9 x 38.3 cm (42.00" x 22.00" x 15.10")
	19.2 cm / 18.5 cm (7.58" / 7.30")
	22.23 kg (49 lbs.) WITH FOAM 17.42 kg (38.4 lbs.) NO FOAM
	■ **
	6 pc. replacement foam set Pick N Pluck™ foam only
DEF STAN 81-41/STANAG 4280	

Case contents not included | ** = ■ and □ : Available upon minimum quantities

0340 CUBE CASE

	52 x 52 x 48.9 cm (20.50" x 20.50" x 19.25")
	45.7 x 45.7 x 45.7 cm (18.00" x 18.00" x 18.00")
	11.4 cm / 34.3 cm (4.50" / 13.50")
	13.5 kg (29.76 lbs.) WITH FOAM 10.89 kg (24 lbs.) NO FOAM
	■ **
	7 pc. replacement foam set, padded divider set, lid organiser
IP67 DEF STAN 81-41/STANAG 4280	

EXTERIOR DIMENSIONS
INTERIOR DIMENSIONS
LID/BOTTOM DEPTH
WEIGHT
COLOURS
AVAILABLE ACCESSORIES
CERTIFICATES

0350 CUBE CASE

	57.1 x 56.9 x 54 cm (22.50" x 22.43" x 21.25")
	50.8 x 50.8 x 50.8 cm (20.00" x 20.00" x 20.00")
	12.7 cm / 38.1 cm (5.00" / 15.00")
	14.52 kg (32.01 lbs.) WITH FOAM 11.79 kg (25.99 lbs.) NO FOAM
	■ **
	7 pc. foam set, padded divider set, lid organiser, cube case mobility package
IP67 DEF STAN 81-41/STANAG 4280	

EXTERIOR DIMENSIONS
INTERIOR DIMENSIONS
LID/BOTTOM DEPTH
WEIGHT
COLOURS
AVAILABLE ACCESSORIES
CERTIFICATES

0370 CUBE CASE

	67.3 x 67.3 x 64.1 cm (26.50" x 26.50" x 25.25")
	60.9 x 60.9 x 60.9 cm (24.00" x 24.00" x 24.00")
	12.7 cm / 48.2 cm (5.00" / 19.00")
	18.6 kg (41 lbs.) WITH FOAM 14.5 kg (31.97 lbs.) NO FOAM
	■ **
	7 pc. foam set, padded divider set, lid organiser, cube case mobility package
IP67 DEF STAN 81-41/STANAG 4280	

EXTERIOR DIMENSIONS
INTERIOR DIMENSIONS
LID/BOTTOM DEPTH
WEIGHT
COLOURS
AVAILABLE ACCESSORIES
CERTIFICATES

0450 MOBILE TOOL CHEST

	60.8 x 37.5 x 45.6 cm (23.95" x 14.75" x 17.95")
	52.2 x 27.9 x 32.1 cm (20.56" x 10.97" x 12.65")
	N/A
	14.97 kg (33 lbs.) NO DRAWERS 18.82 kg (41.5 lbs.) WITH DRAWERS
	■
	Deep drawer, shallow drawer, 4" drawer, top tray, vertical tool pallet and horizontal tool pallet
MIL-STD-810F	

0500 TRANSPORT CASE

	101.4 x 59.5 x 72.7 cm (39.95" x 23.45" x 28.65")
	88.7 x 46.8 x 64.1 cm (34.95" x 18.45" x 25.25")
	5.7 cm / 58.4 cm (2.25" / 23.00")
	26.58 kg (58.6 lbs.) WITH FOAM 22.68 kg (50 lbs.) NO FOAM
	■
	7 pc. replacement foam set, caster wheel kit, pallet riser kit document container accessory
N/A	

0550 TRANSPORT CASE

	129.6 x 69.9 x 57.9 cm (51.05" x 27.54" x 22.79")
	120.8 x 61.1 x 44.9 cm (47.57" x 24.07" x 17.68")
	8.1 cm / 36.8 cm (3.19" / 14.49")
	43.09 kg (95 lbs.) WITH FOAM 35.92 kg (79.2 lbs.) NO FOAM
	■
	6 pc. replacement foam set, caster wheel kit, pallet riser kit document container accessory
IP55	

Case contents not included | ** = ■ and □ : Available upon minimum quantities

LONG CASES

Ideal for weapons but also used by industrial workers for instruments and gear. Equipped with sturdy polyurethane wheels for ease of transport.

1700 LONG CASE

Similarly sized Peli Storm Case: iM3100



Shown with custom foam set

96.8 x 40.6 x 15.5 cm
(38.12" x 16.00" x 6.12")90.8 x 34.3 x 13.3 cm
(35.75" x 13.50" x 5.25")4.4 cm / 8.9 cm
(1.75" / 3.50")7.7 kg (16.98 lbs.) WITH FOAM
7.3 kg (16.09 lbs.) NO FOAM

3 pc. replacement foam set

IP67 • MIL C-4150J
DEF STAN 81-41/STANAG 4280

EXTERIOR DIMENSIONS

INTERIOR DIMENSIONS

LID/BOTTOM DEPTH

WEIGHT

COLOURS

AVAILABLE ACCESSORIES

CERTIFICATES

1720 LONG CASE

Similarly sized Peli Storm Case: iM3200

112.7 x 40.6 x 15.5 cm
(44.37" x 16.00" x 6.12")106.6 x 34.3 x 13.3 cm
(42.00" x 13.50" x 5.25")4.4 cm / 8.9 cm
(1.75" / 3.50")8.6 kg (18.96 lbs.) WITH FOAM
7.6 kg (16.76 lbs.) NO FOAM

3 pc. replacement foam set

DEF STAN 81-41/STANAG 4280

EXTERIOR DIMENSIONS

INTERIOR DIMENSIONS

LID/BOTTOM DEPTH

WEIGHT

COLOURS

AVAILABLE ACCESSORIES

CERTIFICATES

Case contents not included | *** = : Only available without foam; : Available upon minimum quantities | **** = and : Without foam version is only available upon min. quantities

1740 LONG CASE

112.1 x 40.9 x 35.5 cm
(44.16" x 16.09" x 14.00")104 x 32.8 x 30.8 cm
(40.98" x 12.92" x 12.51")6.5 cm / 24.3 cm
(2.56" / 9.57")12.25 kg (27 lbs.) WITH FOAM
9.98 kg (22 lbs.) NO FOAM6 pc. replacement foam set,
document container accessory

IP65

EXTERIOR DIMENSIONS

INTERIOR DIMENSIONS

LID/BOTTOM DEPTH

WEIGHT

COLOURS

AVAILABLE ACCESSORIES

CERTIFICATES

1780RF LONG CASE (with Rifle FOAM Insert)

114 x 64.3 x 41.9 cm
(44.90" x 25.32" x 16.50")106.6 x 55.9 x 38.3 cm
(42.00" x 22.00" x 15.10")19.2 cm / 18.5 cm
(7.58" / 7.30")

24.04 kg (53 lbs.) WITH FOAM

High-density foam tray option for
10 firearms with scopes

DEF STAN 81-41/STANAG 4280

*Fits M4, M16 firearms
*Fast loading, lockable
metal cross bar

1780W HL LONG CASE (with Rifle Hard Liner Insert)

114 x 64.3 x 41.9 cm
(44.90" x 25.32" x 16.50")106.6 x 55.9 x 38.3 cm
(42.00" x 22.00" x 15.10")19.2 cm / 18.5 cm
(7.58" / 7.30")

31.03 kg (68.4 lbs.) HARD LINER

Rigid polyethylene tray option for
12 firearms

DEF STAN 81-41/STANAG 4280

*Fits M4, M16 firearms
*Fast loading, lockable metal cross bar

EXTERIOR DIMENSIONS

INTERIOR DIMENSIONS

LID/BOTTOM DEPTH

WEIGHT

COLOURS

AVAILABLE ACCESSORIES

CERTIFICATES

1750 LONG CASE

Similarly sized Peli Storm Case: iM3300

134.6 x 40.6 x 15.5 cm
(53.00" x 16.00" x 6.12")128.2 x 34.3 x 13.3 cm
(50.50" x 13.50" x 5.25")4.4 cm / 8.9 cm
(1.75" / 3.50")11.6 kg (25.57 lbs.) WITH FOAM
10.7 kg (23.59 lbs.) NO FOAM

3 pc. replacement foam set

IP67
DEF STAN 81-41/STANAG 4280

EXTERIOR DIMENSIONS

INTERIOR DIMENSIONS

LID/BOTTOM DEPTH

WEIGHT

COLOURS

AVAILABLE ACCESSORIES

CERTIFICATES

1770 LONG CASE

145.8 x 46.9 x 28.5 cm
(57.42" x 18.48" x 11.23")138.6 x 39.6 x 21.9 cm
(54.58" x 15.58" x 8.63")4.8 cm / 17.1 cm
(1.88" / 6.75")16.33 kg (36 lbs.) WITH FOAM
13.15 kg (29 lbs.) NO FOAM4 pc. replacement foam set,
document container accessory

N/A

EXTERIOR DIMENSIONS

INTERIOR DIMENSIONS

LID/BOTTOM DEPTH

WEIGHT

COLOURS

AVAILABLE ACCESSORIES

CERTIFICATES

Case contents not included | ** = and : Available upon minimum quantities | *** = : Only available without foam; : Available upon minimum quantities

PELI ORGANISATION SOLUTIONS



0340 CUBE CASE
(shown with)

- Cat. No. 0349 lid organiser for 0340 Cube Case
- Cat. No. 0344 0340 with padded divider set

LID ORGANISERS

Made of leather or waterproof ballistic nylon with nylon zippers. A multitude of pockets in various sizes protect and keep your gear organised. Installs with Velcro® strips (included) or self tapping screws.

PADDED DIVIDERS

Main dividers that span the length of the case are complemented by varying sizes of subdividers. Velcro® edges make it easy to reposition these dividers into the spaces you need. See individual accessory configurations product listings for availability.



1610 PELI™ CASE

- Cat. No. 1614 (shown) 1610 case with padded divider set
- Cat. No. 1615 divider set

Case contents not included

LID ORGANISER OPTIONS

CASE	LID ORGANISER OPTIONS			
	MESH	COMPUTER	PHOTO	EMS
1430			1439 Photo ^A	
1440	1449 Mesh ^A			
1490		1498 Computer ^B		
1495		1495 Computer ^B		
1500	1509 Mesh		1508 Photo	1505 EMS ^B
1510	1519 Mesh ^A			
1520	1509 Mesh		1508 Photo ^B	
1550				1555 EMS ^B
1560	1569 Mesh			
1600	1609 Mesh ^B			1605 EMS ^A
1610	1609 Mesh ^B			
1620	1609 Mesh ^B			
1630	1639 Mesh ^A			
1640	0379 Mesh ^A			
1650	1659 Mesh ^A			
1660	1669 Mesh ^A			
1690	1699 Mesh ^A			
0340	0349 Mesh ^A			
0350	0359 Mesh ^A			
0370	0379 Mesh ^A			

A= With mounting screws **B=** With mounting Velcro®

MESH LID ORGANISERS

present an array of compartments with mesh nylon zipper pockets to house, protect, and organise various gear.

COMPUTER LID ORGANISERS

are styled with deep expandable folder pockets and sleeves for various office attaché style components.

PHOTO LID ORGANISERS

have multiple compartments including an assortment of elastic strapping and mesh nylon zipper pockets to organise and protect photo equipment.

EMS LID ORGANISERS

is a specially engineered lid organise with clear pockets to quickly spot medical supplies in any emergency.

PADDED DIVIDER OPTIONS

CASE	LAYERS	CASE WITH DIVIDERS (CAT. NO.)	DIVIDER SET ONLY (CAT. NO.)
1450	1	1454	1455
1500	1	1504	1505
1510	1	1514	1515
1520	1	1524	1525
1550	1	1554	1555
1560	1	1564	1565
1600	1	1604	1605
1610	1	1614	1615
1620	2	1624	1625
1630	2	1634	1635
1640	2	1644	1645
1650	1	1654	1655
1660	2	1664	1665
1690	2	1694	1695
0340	2	0344	0345
0350	2	0354	0355
0370	2	0374	0375

CASE	EXTERIOR	INTERIOR	LID DEPTH	BOTTOM DEPTH	WEIGHT WITH FOAM	WEIGHT WITHOUT FOAM	COLOURS	BUOYANCY MAXIMUM	TEMPERATURE RANGE (MIN/MAX)	CERTIFICATES
1730	95.2 x 68.9 x 36.5 cm (37.50" x 27.13" x 14.37")	86.3 x 60.9 x 31.7 cm (34.00" x 24.00" x 12.50")	6.3 cm (2.50")	25.4 cm (10.00")	17.24 kg (38 lbs.)	13.61 kg (30 lbs.)	■**	189 kg (416 lbs.)	-40 / 99° C (-40 / 210° F)	IP67
1780	114 x 64.3 x 41.9 cm (44.90" x 25.32" x 16.50")	106.6 x 55.9 x 38.3 cm (42.00" x 22.00" x 15.10")	19.2 cm (7.58")	18.5 cm (7.30")	22.23 kg (49 lbs.)	17.42 kg (38.4 lbs.)	■**	226.8 kg (500 lbs.)	-40 / 99° C (-40 / 210° F)	DEF STAN 81-41/STANAG 4280
0340	52 x 52 x 48.9 cm (20.50" x 20.50" x 19.25")	45.7 x 45.7 x 45.7 cm (18.00" x 18.00" x 18.00")	11.4 cm (4.50")	34.3 cm (13.50")	13.5 kg (29.76 lbs.)	10.89 kg (24 lbs.)	■**	100 kg (220 lbs.)	-40 / 99° C (-40 / 210° F)	IP67 DEF STAN 81-41/STANAG 4280
0350	57.1 x 56.9 x 54 cm (22.50" x 22.43" x 21.25")	50.8 x 50.8 x 50.8 cm (20.00" x 20.00" x 20.00")	12.7 cm (5.00")	38.1 cm (15.00")	14.52 kg (32.01 lbs.)	11.79 kg (25.99 lbs.)	■**	122 kg (269 lbs.)	-40 / 99° C (-40 / 210° F)	IP67 DEF STAN 81-41/STANAG 4280
0370	67.3 x 67.3 x 64.1 cm (26.50" x 26.50" x 25.25")	60.9 x 60.9 x 60.9 cm (24.00" x 24.00" x 24.00")	12.7 cm (5.00")	48.2 cm (19.00")	18.6 kg (41 lbs.)	14.5 kg (31.97 lbs.)	■**	211 kg (465 lbs.)	-40 / 99° C (-40 / 210° F)	IP67 DEF STAN 81-41/STANAG 4280
0450	60.8 x 37.5 x 45.6 cm (23.95" x 14.75" x 17.95")	52.2 x 27.9 x 32.1 cm (20.56" x 10.97" x 12.65")	N/A	N/A	18.82 kg ^A (41.5 lbs.)	14.97 kg ^B (33 lbs.)	■			MIL-STD-810F
0500	101.4 x 59.5 x 72.7 cm (39.95" x 23.45" x 28.65")	88.7 x 46.8 x 64.1 cm (34.95" x 18.45" x 25.25")	5.7 cm (2.25")	58.4 cm (23.00")	26.58 kg (58.6 lbs.)	22.68 kg (50 lbs.)	■	354 kg (780 lbs.)	-40 / 99° C (-40 / 210° F)	-
0550	129.6 x 69.9 x 57.9 cm (51.05" x 27.54" x 22.79")	120.8 x 61.1 x 44.9 cm (47.57" x 24.07" x 17.68")	8.1 cm (3.19")	36.8 cm (14.49")	43.09 kg (95 lbs.)	35.92 kg (79.2 lbs.)	■	371.95 kg (820 lbs.)	-40 / 99° C (-40 / 210° F)	IP55
1700	96.8 x 40.6 x 15.5 cm (38.12" x 16.00" x 6.12")	90.8 x 34.3 x 13.3 cm (35.75" x 13.50" x 5.25")	4.4 cm (1.75")	8.9 cm (3.50")	7.7 kg (16.98 lbs.)	7.3 kg (16.09 lbs.)	■***	62.1 kg (137 lbs.)	-40 / 99° C (-40 / 210° F)	IP67 · MIL C-4150J DEF STAN 81-41/STANAG 4280
1720	112.7 x 40.6 x 15.5 cm (44.37" x 16.00" x 6.12")	106.6 x 34.3 x 13.3 cm (42.00" x 13.50" x 5.25")	4.4 cm (1.75")	8.9 cm (3.50")	8.6 kg (18.96 lbs.)	7.6 kg (16.76 lbs.)	■ ■ ■ ■ ****	73 kg (161 lbs.)	-40 / 99° C (-40 / 210° F)	DEF STAN 81-41/STANAG 4280
1740	112.1 x 40.9 x 35.5 cm (44.16" x 16.09" x 14.00")	104 x 32.8 x 30.8 cm (40.98" x 12.92" x 12.13")	6.5 cm (2.56")	24.3 cm (9.57")	12.25 kg (27 lbs.)	9.98 kg (22 lbs.)	■**	121.11 kg (267 lbs.)	-40 / 99° C (-40 / 210° F)	IP65
1750	134.6 x 40.6 x 15.5 cm (53.00" x 16.00" x 6.12")	128.2 x 34.3 x 13.3 cm (50.50" x 13.50" x 5.25")	4.4 cm (1.75")	8.9 cm (3.50")	11.6 kg (25.57 lbs.)	10.7 kg (23.59 lbs.)	■***	85 kg (187 lbs.)	-40 / 99° C (-40 / 210° F)	IP67 DEF STAN 81-41/STANAG 4280
1770	145.8 x 46.9 x 28.5 cm (57.42" x 18.48" x 11.23")	138.6 x 39.6 x 21.9 cm (54.58" x 15.58" x 8.63")	4.8 cm (1.88")	17.1 cm (6.75")	16.33 kg (36 lbs.)	13.15 kg (29 lbs.)	■**	127.01 kg (280 lbs.)	N/A	-
1780RF	114 x 64.3 x 41.9 cm (44.90" x 25.32" x 16.50")	106.6 x 55.9 x 38.3 cm (42.00" x 22.00" x 15.10")	19.2 cm (7.58")	18.5 cm (7.30")	24.04 kg (53 lbs.)	N/A	■**	226.8 kg (500 lbs.)	-40 / 99° C (-40 / 210° F)	DEF STAN 81-41/STANAG 4280
1780W	114 x 64.3 x 41.9 cm (44.90" x 25.32" x 16.50")	106.6 x 55.9 x 38.3 cm (42.00" x 22.00" x 15.10")	19.2 cm (7.58")	18.5 cm (7.30")	31.03 kg (68.4 lbs.)	24.04 kg (53 lbs.)	■**	226.8 kg (500 lbs.)	-40 / 99° C (-40 / 210° F)	DEF STAN 81-41/STANAG 4280

CASE SPECIFICATIONS

All Peli™ cases (except Micro Case Series™ cases and 1780 cases) come standard with Pick N Pluck™ foam.

Long Cases with foam come with solid foam (Pick N Pluck™ is not available), except the 1740 that comes with Pick N Pluck™. To order Peli™ Cases without foam add NF to the end of the catalogue number.

* = ■ : Available upon minimum quantities
 ** = ■ and □ : Available upon minimum quantities
 *** = ■ : Only available without foam. □ : Available upon minimum quantities
 **** = ■ and □ : Without foam version is only available upon min. quantities

Most Peli™ cases have a 2 degree draft angle with a bottom radius of 0.66" +/- 0.020". Length and width are measured at the base of the case from the top of the radius.

Depth is measured at the center of the case and includes lid depth. Refer to pelioem.com and download CAD drawings for specifications on desired case.

OPTIONAL CONFIGURATIONS AND ACCESSORIES																					
Case	Foam Set	Padded Dividers	Panel Frame	Lid Organisers	Nameplate	Other	Case	Foam Set	Padded Dividers	Panel Frame	Lid Organisers	Nameplate	Other	Case	Foam Set	Padded Dividers	Panel Frame	Lid Organisers	Nameplate	Other	
1010	1012	-	-	-	-	-	1550	1551	1555/ EMS*	1550 PF	EMS*	YES	-	1660	1661	1665	-	1669	YES	-	
1020	1022	-	-	-	-	-	1430	1431	• 1435 • 1436 Office	1430 PF	1439	YES	• 1432 Strap Kit • 1438 Boat Bracket Kit	1690	1691	1695	-	1699	YES	-	
1030	1032	-	-	-	-	-	1440	1441	• 1445 Utility w/Lid Org • 1446 Office w/ Lid Org	-	1449 Office	YES	-	0340	0341	0345	-	0349	YES	-	
1040	1042	-	-	-	-	-	1470	1471	-	1470 PF	-	YES	1472 Shoulder Strap	0350	0351	0355	-	0359	YES	0357 Mobility Kit	
1050	1052	-	-	-	-	-	1490	1491	-	1490 PF	1498	YES	• 1472 Shoulder Strap • 1499C Computer Insert. Bottom	0370	0371	0375	-	0379	YES	0357 Mobility Kit	
1060	1062	-	-	-	-	-	1495	1481	-	-	1495ALI Attache/ Computer Lid Insert	YES	1472 Shoulder Strap	0450	-	-	-	-	-	-	• 0455DD Deep Drawer • 0455DS Shallow Drawer • 0455DE 4" Drawer • 0455TT Top Tray • 0456 Vertical Tool Pallet • 0457 Horizontal Tool Pallet
1120	1121	-	1120 PF	-	-	-	1560	1561	1565	-	1569	YES	-	0500	0501	-	-	-	YES	• 1630DC Document Container Accessory • 0507 Caster Wheel Kit • 0508 Pallet Riser Kit	
1150	1151	-	1150 PF	-	-	-	1600	1611	1605 / EMS*	-	1609 / EMS*	YES	-	1700	1701	-	-	-	-	-	
1170	1171	-	-	-	-	-	1610	1611	1615	-	1609	YES	-	1720	1721	-	-	-	YES	-	
1200	1201	-	1200 PF	-	-	-	1620	1621	1625	-	1609	YES	-	1740	1741	-	-	-	YES	1630DC Document Container Accessory	
1300	1301	-	1200 PF	-	-	-	1630	1631	1635	-	1639	YES	1630DC Document Container Accessory	1750	1751	-	-	-	YES	-	
1400	1401	-	1400 PF	-	YES	-	1640	1641	1645	-	0379	YES	-	1770	1771	-	-	-	YES	1630DC Document Container Accessory	
1450	1451	1455	1450 PF	-	YES	-	1650	1651	1655	-	1659	YES	-	1780	1781	-	-	-	YES	-	
1500	1501	1505/ EMS*	1500 PF	1508/ EMS*	YES	-															
1510	1511	1515	-	1519	YES	-															
1520	1521	1525	1520 PF	1509	YES	-															

*EMS Divider / Lid Organiser

Optional configurations and accessories do not apply to the i1010, 1015, i1015, 1460 cases.

THE PELI™ STORM CASE™



Lightweight and rugged, the Peli™ Storm Case™ is the result of years of perfecting and testing in both the laboratory and the field. From the proprietary HPX™ plastic resin that is tough during low-temperature impact testing, to the patented Press & Pull latch that opens easily, every facet of these lightweight cases has been created to defend your vital gear.

The Peli™ Storm Case™ has been designed to meet or exceed military testing requirements. Many are airline size appropriate, and all are internationally shippable.

ANATOMY OF A PELI™ STORM CASE™



A RESILIENT HPX™
High impact shell.



B PRESS & PULL LATCHES

Unique Press & Pull Latches open with the push of a button, yet stay closed securely under impact or stress.

C RUGGED IN-LINE WHEELS

Ball bearing wheels provide low-friction, low drag rolling for easy movement of heavy loads. Available on select models.

D DOUBLE-LAYERED, SOFT-GRIP HANDLES

Tested and proven strong, these comfort grips withstand heavy loads.

E MOULDED IN HASPS

Unbreakable moulded-in hasps, allow you to add standard size padlocks, offering another measure of security.

F ROUNDED DEFLECTIVE CORNERS

The corners of a Peli™ Storm Case™ deflect and absorb impact, dispensing kinetic energy throughout the case to ensure contents remain safe drop after drop.

G VORTEX™ VALVE

Permanently attached Vortex™ valve automatically adjusts air pressure without letting in water, and won't unscrew from the case.

COLOURS



BLACK



YELLOW



OD GREEN

SMALL CASES

Perfect for small gear and instruments but still have features found in larger cases: strong HPX™ resin construction, Vortex™ valve, and Press & Pull latches.

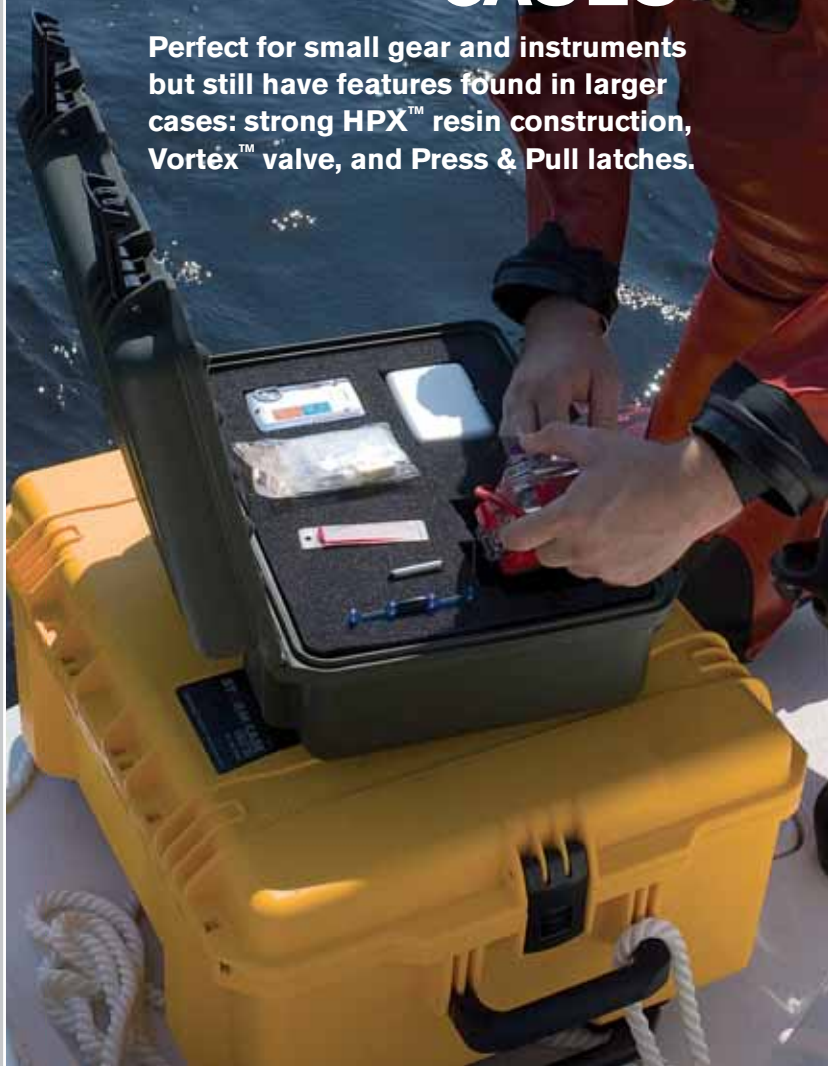

EXTERIOR DIMENSIONS
INTERIOR DIMENSIONS
LID/BOTTOM DEPTH
WEIGHT
COLOURS
AVAILABLE ACCESSORIES
CERTIFICATES

IM2050 STORM CASE Similarly sized Peli Case: 1200



30 x 24.9 x 11.9 cm (11.80" x 9.80" x 4.70")
24.1 x 19 x 10.8 cm (9.50" x 7.50" x 4.25")
3.8 cm / 7 cm (1.50" / 2.75")
1.36 kg (3 lbs.) WITH FOAM 1.22 kg (2.7 lbs.) NO FOAM
■ ■ ■
3 pc. foam set, lid stay, padded shoulder strap, manual purge valve, padded dividers, base bezel kit
MIL-STD-810F • FED-STD-101C ATA 300

EXTERIOR DIMENSIONS
INTERIOR DIMENSIONS
LID/BOTTOM DEPTH
WEIGHT
COLOURS
AVAILABLE ACCESSORIES
CERTIFICATES

IM2075 STORM CASE Similarly sized Peli Case: 1300



Shown with optional panel frame

30 x 24.9 x 19.6 cm (11.80" x 9.80" x 7.70")
24.1 x 19 x 18.4 cm (9.50" x 7.50" x 7.25")
3.8 cm / 14.6 cm (1.50" / 5.75")
1.68 kg (3.7 lbs.) WITH FOAM 1.5 kg (3.3 lbs.) NO FOAM
■ ■ ■
4 pc. foam set, lid stay, padded shoulder strap, manual purge valve, padded dividers, base bezel kit
MIL-STD-810F • FED-STD-101C ATA 300

EXTERIOR DIMENSIONS
INTERIOR DIMENSIONS
LID/BOTTOM DEPTH
WEIGHT
COLOURS
AVAILABLE ACCESSORIES
CERTIFICATES

IM2100 STORM CASE Similarly sized Peli Case: 1400



36.1 x 28.9 x 16.5 cm (14.20" x 11.40" x 6.50")
33 x 23.4 x 15.2 cm (13.00" x 9.20" x 6.00")
5.1 cm / 10.2 cm (2.00" / 4.00")
2.22 kg (4.9 lbs.) WITH FOAM 1.91 kg (4.2 lbs.) NO FOAM
■ ■ ■
4 pc. foam set, lid stay, padded shoulder strap, manual purge valve, padded dividers, base bezel kit
MIL-STD-810F • FED-STD-101C ATA 300

Case contents not included

IM2050GP1 Similarly sized Peli Case: 1200



Holds 1 GoPro® camera and accessories

30 x 24.9 x 11.9 cm (11.80" x 9.80" x 4.70")
24.1 x 19 x 10.8 cm (9.50" x 7.50" x 4.25")
3.8 cm / 7 cm (1.50" / 2.75")
1.36 kg (3 lbs.) WITH FOAM 1.22 kg (2.7 lbs.) NO FOAM
■
Lid stay, padded shoulder strap, manual purge valve, base bezel kit
MIL-STD-810F • FED-STD-101C ATA 300

EXTERIOR DIMENSIONS
INTERIOR DIMENSIONS
LID/BOTTOM DEPTH
WEIGHT
COLOURS
AVAILABLE ACCESSORIES
CERTIFICATES

IM2050GP2 Similarly sized Peli Case: 1200



Holds 2 GoPro® cameras and accessories

30 x 24.9 x 11.9 cm (11.80" x 9.80" x 4.70")
24.1 x 19 x 10.8 cm (9.50" x 7.50" x 4.25")
3.8 cm / 7 cm (1.50" / 2.75")
1.36 kg (3 lbs.) WITH FOAM 1.22 kg (2.7 lbs.) NO FOAM
■
Lid stay, padded shoulder strap, manual purge valve, base bezel kit
MIL-STD-810F • FED-STD-101C ATA 300

EXTERIOR DIMENSIONS
INTERIOR DIMENSIONS
LID/BOTTOM DEPTH
WEIGHT
COLOURS
AVAILABLE ACCESSORIES
CERTIFICATES



Photo by Martin Schmeibell

EXTERIOR DIMENSIONS
INTERIOR DIMENSIONS
LID/BOTTOM DEPTH
WEIGHT
COLOURS
AVAILABLE ACCESSORIES
CERTIFICATES

IM2370 STORM LAPTOP CASE



50.8 x 37.3 x 14.7 cm (20.00" x 14.70" x 5.80")
46.2 x 30.7 x 13.2 cm (18.20" x 12.10" x 5.20")
4.3 cm / 8.9 cm (1.70" / 3.50")
3.27 kg (7.2 lbs.) WITH FOAM 2.59 kg (5.7 lbs.) NO FOAM
■ ■
4 pc. foam set, padded shoulder strap, manual purge valve, padded dividers, computer tray, utility organiser
MIL-STD-810F • FED-STD-101C ATA 300

Case contents not included

LAPTOP CASES

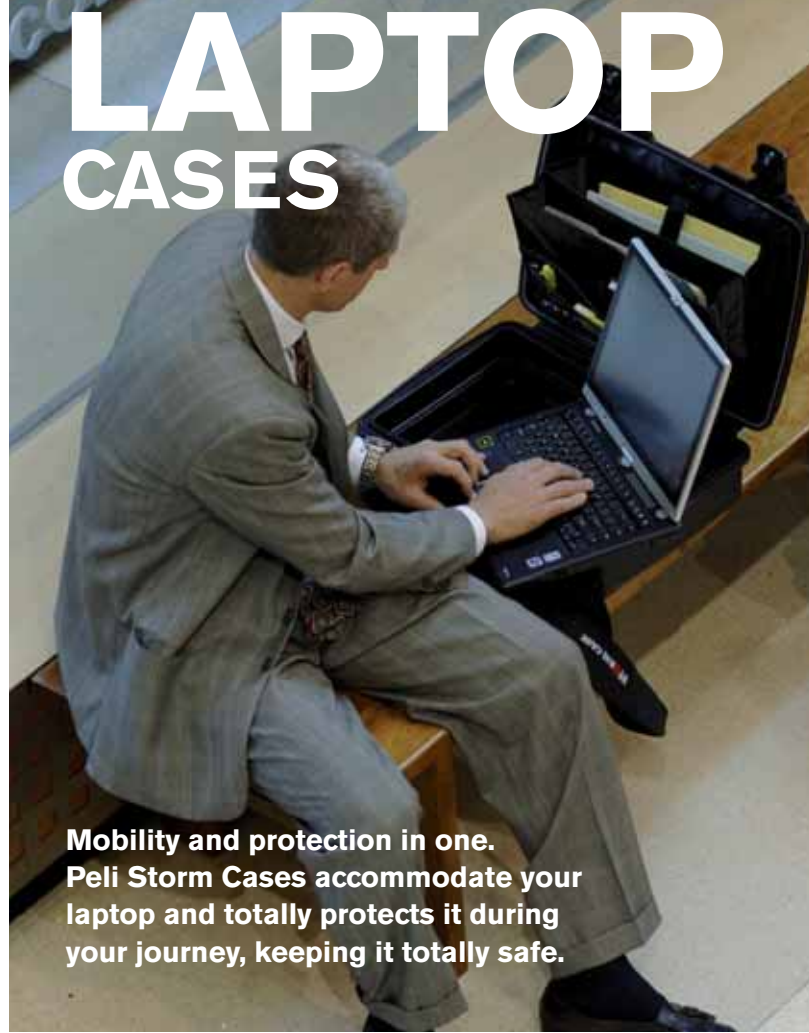

Mobility and protection in one. Peli Storm Cases accommodate your laptop and totally protects it during your journey, keeping it totally safe.

MEDIUM CASES



From firefighters, EMTs, and law enforcement to industrial engineers and photographers, there's a Pelican™ Storm Case™ for every professional. Built strong with multiple interior options to protect the most sensitive gear.

EXTERIOR DIMENSIONS
INTERIOR DIMENSIONS
LID/BOTTOM DEPTH
WEIGHT
COLOURS
AVAILABLE ACCESSORIES
CERTIFICATES

IM2200 STORM CASE Similarly sized Peli Case: 1450



41.1 x 32.2 x 16.8 cm (16.20" x 12.70" x 6.60")
38.1 x 26.7 x 15.2 cm (15.00" x 10.50" x 6.00")
5.1 cm / 10.2 cm (2.00" / 4.00")
2.77 kg (6.1 lbs.) WITH FOAM 2.22 kg (4.9 lbs.) NO FOAM
4 pc. foam set, lid stay, padded shoulder strap, manual purge valve, padded dividers, base bezel kit, lid bezel kit
MIL-STD-810F • FED-STD-101C ATA 300

EXTERIOR DIMENSIONS
INTERIOR DIMENSIONS
LID/BOTTOM DEPTH
WEIGHT
COLOURS
AVAILABLE ACCESSORIES
CERTIFICATES

IM2300 STORM CASE Similarly sized Peli Case: 1500



46.2 x 34 x 17 cm (18.20" x 13.40" x 6.70")
43.2 x 29.7 x 15.7 cm (17.00" x 11.70" x 6.20")
5.1 cm / 10.7 cm (2.00" / 4.20")
3.22 kg (7.1 lbs.) WITH FOAM 2.68 kg (5.9 lbs.) NO FOAM
4 pc. foam set, lid stay, padded shoulder strap, purge valve, padded dividers, base bezel kit, lid bezel kit, lid organiser, photography pallet
MIL-STD-810F • FED-STD-101C ATA 300

EXTERIOR DIMENSIONS
INTERIOR DIMENSIONS
LID/BOTTOM DEPTH
WEIGHT
COLOURS
AVAILABLE ACCESSORIES
CERTIFICATES

IM2306 STORM CASE



46.2 x 21.3 x 17 cm (18.20" x 8.40" x 6.70")
43.2 x 16 x 15.7 cm (17.00" x 6.30" x 6.20")
5.1 cm / 10.7 cm (2.00" / 4.20")
2.13 kg (4.7 lbs.) WITH FOAM 1.95 kg (4.3 lbs.) NO FOAM
4 pc. foam set, lid stay, padded shoulder strap, manual purge valve, padded dividers, base bezel kit, lid bezel kit
MIL-STD-810F • FED-STD-101C ATA 300

Case contents not included

IM2400 STORM CASE Similarly sized Peli Case: 1520



48.7 x 38.6 x 18.5 cm (19.20" x 15.20" x 7.30")
45.7 x 33 x 17 cm (18.00" x 13.00" x 6.70")
5.1 cm / 11.9 cm (2.00" / 4.70")
3.54 kg (7.8 lbs.) WITH FOAM 2.95 kg (6.5 lbs.) NO FOAM
4 pc. foam set, lid stay, padded shoulder strap, purge valve, padded dividers, base bezel kit, lid bezel kit, lid organiser, photography pallet
MIL-STD-810F • FED-STD-101C ATA 300

IM2435 STORM PILOT CASE



47.3 x 23.5 x 41.9 cm (18.63" x 9.25" x 16.5")
44.4 x 16.5 x 39.4 cm (17.5" x 6.5" x 15.5")
5.1 cm / 34.3 cm (2.00" / 13.50")
5.06 kg. (11.15 lbs.) WITH FOAM 4.54kg (10 lbs.) NO FOAM
5 pc. foam set, padded dividers, lid organiser
MIL-STD-810F • FED-STD-101C ATA 3000

IM2450 STORM CASE



48.7 x 38.6 x 22.9 cm (19.20" x 15.20" x 9.00")
45.7 x 33 x 21.3 cm (18.00" x 13.00" x 8.40")
5.1 cm / 16.2 cm (2.00" / 6.40")
4.04 kg (8.9 lbs.) WITH FOAM 3.36 kg (7.4 lbs.) NO FOAM
5 pc. foam set, lid stay, padded shoulder strap, manual purge valve, padded dividers, base bezel kit, lid bezel kit, photography pallet
MIL-STD-810F • FED-STD-101C ATA 300

EXTERIOR DIMENSIONS
INTERIOR DIMENSIONS
LID/BOTTOM DEPTH
WEIGHT
COLOURS
AVAILABLE ACCESSORIES
CERTIFICATES

IM2500 STORM CARRY ON CASE Similarly sized Peli Case: 1510



55.1 x 35.8 x 22.6 cm (21.70" x 14.10" x 8.90")
52 x 29.2 x 18.3 cm (20.50" x 11.50" x 7.20")
5.1 cm / 13.2 cm (2.00" / 5.20")
6.21 kg (13.7 lbs.) WITH FOAM 5.03 kg (11.1 lbs.) NO FOAM
5 pc. foam set, lid stay, padded shoulder strap, manual purge valve, padded dividers, base bezel kit, lid bezel kit, utility organiser
MIL-STD-810F • FED-STD-101C ATA 300

EXTERIOR DIMENSIONS
INTERIOR DIMENSIONS
LID/BOTTOM DEPTH
WEIGHT
COLOURS
AVAILABLE ACCESSORIES
CERTIFICATES

IM2600 STORM CASE Similarly sized Peli Case: 1550



53.8 x 40.6 x 21.1 cm (21.20" x 16.00" x 8.30")
50.8 x 35.5 x 19.6 cm (20.00" x 14.00" x 7.70")
5.1 cm / 14.5 cm (2.00" / 5.70")
5.26 kg (11.6 lbs.) WITH FOAM 3.86 kg (8.5 lbs.) NO FOAM
5 pc. foam set, lid stay, padded shoulder strap, purge valve, padded dividers, base bezel kit, lid bezel kit, lid organiser, photography pallet
MIL-STD-810F • FED-STD-101C ATA 300

EXTERIOR DIMENSIONS
INTERIOR DIMENSIONS
LID/BOTTOM DEPTH
WEIGHT
COLOURS
AVAILABLE ACCESSORIES
CERTIFICATES

IM2620 STORM CASE



53.8 x 40.6 x 26.9 cm (21.20" x 16.00" x 10.60")
50.8 x 35.5 x 25.4 cm (20.00" x 14.00" x 10.00")
5.1 cm / 20.3 cm (2.00" / 8.00")
6.58 kg (14.5 lbs.) WITH FOAM 5.67 kg (12.5 lbs.) NO FOAM
6 pc. foam set, lid stay, padded shoulder strap, purge valve, padded dividers, base bezel kit, lid bezel kit, lid organiser, photography pallet
MIL-STD-810F • FED-STD-101C ATA 300

Case contents not included

LARGE CASES

In the lab or in the field, the large Peli™ Storm Case™ with HPX™ resin construction protect and store valuable and sensitive samples and testing instruments from the elements. Pick N Pluck™ foam adds extra protection from shock during transport.

IM2700 STORM CASE Similarly sized Peli Case: 1600



62.5 x 50 x 21.8 cm
(24.60" x 19.70" x 8.60")
55.9 x 43.2 x 20.3 cm
(22.00" x 17.00" x 8.00")
5.1 cm / 15.2 cm
2.00" / 6.00"

6.53 kg (14.4 lbs.) WITH FOAM
5.03 kg (11.1 lbs.) NO FOAM



5 pc. foam set, lid stay, padded shoulder strap, manual purge valve, padded dividers, base bezel kit, lid bezel kit, utility organiser

MIL-STD-810F • FED-STD-101C
ATA 300

EXTERIOR DIMENSIONS

INTERIOR DIMENSIONS

LID/BOTTOM DEPTH

WEIGHT

COLOURS

AVAILABLE ACCESSORIES

CERTIFICATES

IM2875 STORM CASE



63.2 x 60.2 x 33.3 cm
(24.90" x 23.70" x 13.10")
57.1 x 53.6 x 28.9 cm
(22.50" x 21.10" x 11.40")

5.1 cm / 23.9 cm
(2.00" / 9.40")

11.16 kg (24.6 lbs.) WITH FOAM
9.12 kg (20.1 lbs.) NO FOAM



7 pc. foam set, lid stay, manual purge valve, padded dividers, base bezel kit, lid bezel kit, utility organiser

MIL-STD-810F • FED-STD-101C
ATA 300

EXTERIOR DIMENSIONS

INTERIOR DIMENSIONS

LID/BOTTOM DEPTH

WEIGHT

COLOURS

AVAILABLE ACCESSORIES

CERTIFICATES

IM2720 STORM CASE Similarly sized Peli Case: 1610



62.5 x 50 x 29.7 cm
(24.60" x 19.70" x 11.70")

55.9 x 43.2 x 25.4 cm
(22.00" x 17.00" x 10.00")

5.1 cm / 20.3 cm
(2.00" / 8.00")

9.98 kg (22 lbs.) WITH FOAM
7.62 kg (16.8 lbs.) NO FOAM



5 pc. foam set, lid stay, manual purge valve, padded dividers, base bezel kit, lid bezel kit, utility organiser

MIL-STD-810F • FED-STD-101C
ATA 300

EXTERIOR DIMENSIONS

INTERIOR DIMENSIONS

LID/BOTTOM DEPTH

WEIGHT

COLOURS

AVAILABLE ACCESSORIES

CERTIFICATES

IM2950 STORM CASE Similarly sized Peli Case: 1650



79.5 x 51.8 x 31 cm
(31.30" x 20.40" x 12.20")

73.6 x 45.7 x 26.7 cm
(29.00" x 18.00" x 10.50")

5.1 cm / 21.6 cm
(2.00" / 8.50")

13.02 kg (28.7 lbs.) WITH FOAM
9.43 kg (20.8 lbs.) NO FOAM



6 pc. foam set, lid stay, manual purge valve, padded dividers, base bezel kit, lid bezel kit, utility organiser

MIL-STD-810F • FED-STD-101C
ATA 300

EXTERIOR DIMENSIONS

INTERIOR DIMENSIONS

LID/BOTTOM DEPTH

WEIGHT

COLOURS

AVAILABLE ACCESSORIES

CERTIFICATES

IM2750 STORM CASE Similarly sized Peli Case: 1620



62.5 x 50 x 36.6 cm
(24.60" x 19.70" x 14.40")

55.9 x 43.2 x 32.2 cm
(22.00" x 17.00" x 12.70")

5.1 cm / 27.2 cm
(2.00" / 10.70")

10.61 kg (23.4 lbs.) WITH FOAM
8.39 kg (18.5 lbs.) NO FOAM



7 pc. foam set, lid stay, manual purge valve, padded dividers, base bezel kit, lid bezel kit, utility organiser

MIL-STD-810F • FED-STD-101C
ATA 300

EXTERIOR DIMENSIONS

INTERIOR DIMENSIONS

LID/BOTTOM DEPTH

WEIGHT

COLOURS

AVAILABLE ACCESSORIES

CERTIFICATES

IM2975 STORM TRANSPORT CASE



79.5 x 51.8 x 39.4 cm
(31.30" x 20.40" x 15.50")

73.6 x 45.7 x 35 cm
(29.00" x 18.00" x 13.80")

5.1 cm / 30 cm
(2.00" / 11.80")

13.38 kg (29.5 lbs.) WITH FOAM
10.34 kg (22.8 lbs.) NO FOAM



8 pc. foam set, lid stay, manual purge valve, padded dividers, base bezel kit, lid bezel kit, utility organiser

MIL-STD-810F • FED-STD-101C
ATA 300

EXTERIOR DIMENSIONS

INTERIOR DIMENSIONS

LID/BOTTOM DEPTH

WEIGHT

COLOURS

AVAILABLE ACCESSORIES

CERTIFICATES



EXTERIOR DIMENSIONS
INTERIOR DIMENSIONS
LID/BOTTOM DEPTH
WEIGHT
COLOURS
AVAILABLE ACCESSORIES
CERTIFICATES

IM3075 STORM TRANSPORT CASE

	84.5 x 62 x 49 cm (33.30" x 24.40" x 19.30")
	75.7 x 52.8 x 45.2 cm (29.80" x 20.80" x 17.80")
	10.2 cm / 34.9 cm (4.00" / 13.75")
	20.41 kg (45 lbs.) WITH FOAM 14.29 kg (31.5 lbs.) NO FOAM
	
	7 pc. foam set, lid stay, manual purge valve, padded dividers, base bezel kit, lid bezel kit, utility organiser
	MIL-STD-810F • FED-STD-101C ATA 300

EXTERIOR DIMENSIONS
INTERIOR DIMENSIONS
LID/BOTTOM DEPTH
WEIGHT
COLOURS
AVAILABLE ACCESSORIES
CERTIFICATES

IM3100 STORM CASE Similarly sized Peli Case: 1700

	101.1 x 41.9 x 17 cm (39.80" x 16.50" x 6.70")
	92.7 x 35.5 x 15.2 cm (36.50" x 14.00" x 6.00")
	5.1 cm / 10.2 cm (2.00" / 4.00")
	8.98 kg (19.8 lbs.) WITH FOAM 6.89 kg (15.2 lbs.) NO FOAM
	
	4 pc. foam set, lid stay, manual purge valve, padded shoulder strap
	MIL-STD-810F • FED-STD-101C ATA 300

EXTERIOR DIMENSIONS
INTERIOR DIMENSIONS
LID/BOTTOM DEPTH
WEIGHT
COLOURS
AVAILABLE ACCESSORIES
CERTIFICATES

IM3200 STORM CASE Similarly sized Peli Case: 1720

	119.8 x 41.9 x 17 cm (47.20" x 16.50" x 6.70")
	111.7 x 35.5 x 15.2 cm (44.00" x 14.00" x 6.00")
	5.1 cm / 10.2 cm (2.00" / 4.00")
	9.57 kg (21.1 lbs.) WITH FOAM 8.03 kg (17.7 lbs.) NO FOAM
	
	4 pc. foam set, lid stay, manual purge valve, padded shoulder strap
	MIL-STD-810F • FED-STD-101C ATA 300

Case contents not included

IM3220 STORM CASE

	119.8 x 41.9 x 23.4 cm (47.20" x 16.50" x 9.20")
	111.7 x 35.5 x 21.6 cm (44.00" x 14.00" x 8.50")
	5.1 cm / 16.5 cm (2.00" / 6.50")
	11.25 kg (24.8 lbs.) WITH FOAM 9.25 kg (20.4 lbs.) NO FOAM
	
	4 pc. foam set, lid stay, manual purge valve, padded shoulder strap
	MIL-STD-810F • FED-STD-101C ATA 300

EXTERIOR DIMENSIONS
INTERIOR DIMENSIONS
LID/BOTTOM DEPTH
WEIGHT
COLOURS
AVAILABLE ACCESSORIES
CERTIFICATES

IM3300 STORM CASE Similarly sized Peli Case: 1750

	136.6 x 41.9 x 17 cm (53.80" x 16.50" x 6.70")
	128.2 x 35.5 x 15.2 cm (50.50" x 14.00" x 6.00")
	5.1 cm / 10.2 cm (2.00" / 4.00")
	10.43 kg (23 lbs.) WITH FOAM 8.66 kg (19.1 lbs.) NO FOAM
	
	4 pc. foam set, lid stay, manual purge valve, padded shoulder strap
	MIL-STD-810F • FED-STD-101C ATA 300



Case contents not included

PELI™ STORM CASE™ ORGANISATION SOLUTIONS



LID ORGANISERS

Customise your case with a lightweight lid organiser, utility organiser or photo pallet to keep your gear organised and protected inside. The organisers fit perfectly inside the lid of the case and are covered with a water-resistant, PVC-coated, high denier nylon fabric for strength and protection from the elements. Installs with Velcro® strips (included).

PADDED DIVIDERS

Main dividers that span the length of the case are complemented by varying sizes of subdividers. Velcro® edges make it easy to reposition these dividers into the spaces you need. See individual accessory configurations product listings for availability.



LID ORGANISERS OPTIONS

CASE	PHOTOGRAPHER'S ORGANISER	LID ORGANISER	UTILITY ORGANISER
	iM2300	iM24XX-PHOTOPALLET	iM2300-LIDORG
iM2370		iM2370-LIDORG	iM2370-UTILITYORG
iM2400	iM24XX-PHOTOPALLET	iM24XX-LIDORG	
iM 2435		iM2435-LIDORG	
iM2450	iM24XX-PHOTOPALLET	iM24XX-LIDORG	
iM2500			iM2500-UTILITYORG
iM2600		iM26XX-LIDORG	iM26XX-UTILITYORG
iM2620		iM26XX-LIDORG	iM26XX-UTILITYORG
iM2700			iM27XX-UTILITYORG
iM2720			iM27XX-UTILITYORG
iM2750			iM27XX-UTILITYORG
iM2875			iM2875-UTILITYORG
iM2950			iM29XX-UTILITYORG
iM2975			iM29XX-UTILITYORG
iM3075			iM30XX-UTILITYORG
	Present an array of compartments including an assortment of elastic strapping and mesh nylon zipper pockets to house, protect, and organise your gear.	Are styled with deep expandable folder pockets and sleeves for various office attaché style components.	Offer various folder pockets, sleeves, and include a vast array of mesh nylon zipper pockets to house, protect, and organise gear.

Lid Organisers are installed with Velcro® (included)

PADDED DIVIDER OPTIONS

CASE	LAYERS	DIVIDER SET ONLY
iM2050	1	iM2050-DIV
iM2075	1	iM2075-DIV
iM2100	1	iM2100-DIV
iM2200	1	iM2200-DIV
iM2300	1	iM2300-DIV
iM2306	1	iM2306-DIV
iM2370	1	iM2370-DIV
iM2400	1	iM2400-DIV
iM2435	1	iM2435-DIV-LIDORG
iM2450	1	iM2450-DIV
iM2500	1	iM2500-DIV
iM2600	1	iM2600-DIV
iM2620	1	iM2620-DIV
iM2700	1	iM2700-DIV
iM2720	1	iM2720-DIV
iM2750	2	iM2750-DIV
iM2875	1	iM2875-DIV
iM2950	1	iM2950-DIV
iM2975	2	iM2975-DIV
iM3075	2	iM3075-DIV

ROTO PACK: MORE THAN A BOX



SPECIALTY PRODUCTS



SINGLE LID CASES



**BLACK BOX
RACKMOUNT CASES**



THE LINE UP:



SPECIALTY PRODUCTS

Our specialty products are well engineered portable workspace solutions. They range from portable desks that set up in minutes to storage chests with metal drawers and dividers to keep all your supplies safe and organised. Whatever your need, whatever the environment, we have a durable solution.



SINGLE LID CASES

Transport and protect your equipment in our Single Lid Cases. These cases are lightweight, shockproof, watertight, dustproof, heat, and chemical-resistant, which make them extremely tough and offer ultimate protection that will move your equipment from point A to point B without a scratch.



**BLACK BOX
RACKMOUNT CASES**

These lightweight, compact, and double ended cases offer light to medium duty protection and boast significantly better light duty shock performance than the competition. The use of recycled materials in the shell and a sturdy steel frame offer great value while upholding Peli's industry-leading standards. When you need to be cost-conscious but can't sacrifice performance, a BlackBox is the answer.



Protect and transport anything from LCD monitors to aircraft parts. One-piece construction moulded from lightweight, high-impact polyethylene with patented metal inserts for added strength.

SINGLE LID CASES



TRUNK						
STANDARD FEATURES						COLOURS
<ul style="list-style-type: none"> • Comfort Grip Handles • Positive anti-shear interlocks, which prevent lid separation after impact • Reinforced corners and edges for additional impact protection • Moulded-in ribs and corrugations for secure, non-slip stacking, columnar strength and added protection • Recessed hardware for extra protection • Airtight lid gasket and PRV (pressure relief valve) 						■
CATALOGUE NUMBER	EXTERIOR DIMENSIONS	INTERIOR DIMENSIONS	BASE DEPTH	LID DEPTH/TYPE	SPECIAL FEATURES	
AL3018-1505-RP-032	83.2 x 53 x 55.7 cm	75.5 x 45.4 x 51.1 cm	37.8 cm	13.3 cm/ Hinged Lid	std edge casters	
AL3418-1005-RP-032	94.4 x 53 x 44 cm	86.8 x 45.4 x 39 cm	25.7 cm	13.3 cm/ Hinged Lid	std edge casters	
AL4024-1305-RP-032	108.8 x 69.3 x 51.3 cm	101.2 x 61.7 x 45.7 cm	32.4 cm	13.3 cm/ Hinged Lid	std edge casters	
AL5424-2306-RP-032	144.4 x 68.4 x 85.7 cm	136.8 x 60.8 x 73.3 cm	57.8 cm	15.5 cm/ Hinged Lid		

 Forklift Skidrunner (one-piece moulded skid-runners provide clearance for forklift tines and pallet jacks)

FLAT					
STANDARD FEATURES					COLOURS
<ul style="list-style-type: none"> • Comfort Grip Handles • Positive anti-shear interlocks, which prevent lid separation after impact • Reinforced corners and edges for additional impact protection • Moulded-in ribs and corrugations for secure, non-slip stacking, columnar strength and added protection • Recessed hardware for extra protection • Airtight lid gasket and PRV (pressure relief valve) 					■
CATALOGUE NUMBER	EXTERIOR DIMENSIONS	INTERIOR DIMENSIONS	BASE DEPTH	LID DEPTH/TYPE	SPECIAL FEATURES
AL1616-0505-RP-032	47.6 x 47.9 x 31 cm	40 x 40.3 x 26.8 cm	13.8 cm	13 cm/ Hinged Lid	no casters available
AL2013-0903-RP-032	58.1 x 40.6 x 35.3 cm	50.5 x 33 x 31.2 cm	23.6 cm	7.6 cm/ Hinged Lid	no casters available
AL5415-1026-RP-032	144.9 x 47.9 x 100.6 cm	138.7 x 40.3 x 91.1 cm	25.4 cm	65.7 cm/ Removable Lid	2 std. edge casters and 2 casters



LONG					
STANDARD FEATURES					COLOURS
<ul style="list-style-type: none"> • Comfort Grip Handles • Positive anti-shear interlocks, which prevent lid separation after impact • Reinforced corners and edges for additional impact protection • Moulded-in ribs and corrugations for secure, non-slip stacking, columnar strength and added protection • Recessed hardware for extra protection • Airtight lid gasket and PRV (pressure relief valve) 					■
CATALOGUE NUMBER	EXTERIOR DIMENSIONS	INTERIOR DIMENSIONS	BASE DEPTH	LID DEPTH/TYPE	SPECIAL FEATURES
AL6912-1003-RP-032	183.7 x 38.1 x 41.3 cm	176.1 x 30.5 x 35.8 cm	26.6 cm	9.1 cm/ Hinged Lid	no casters available

CUBE					
STANDARD FEATURES					COLOURS
<ul style="list-style-type: none"> • Comfort Grip Handles • Positive anti-shear interlocks, which prevent lid separation after impact • Reinforced corners and edges for additional impact protection • Moulded-in ribs and corrugations for secure, non-slip stacking, columnar strength and added protection • Recessed hardware for extra protection • Airtight lid gasket and PRV (pressure relief valve) 					■
CATALOGUE NUMBER	EXTERIOR DIMENSIONS	INTERIOR DIMENSIONS	BASE DEPTH	LID DEPTH/TYPE	SPECIAL FEATURES
AL2624-1805-RP-032	73.9 x 68.6 x 67.5 cm	67 x 60.9 x 58.1 cm	45.2 cm	12.9 cm/ Hinged Lid	no casters available
AL3834-1617-RP-032	104.4 x 94.2 x 98.6 cm	96.8 x 86.6 x 83.8 cm	40 cm	43.8 cm/ Removable Lid	



SPECIALTY PRODUCTS



Erect a command center virtually anywhere. Modular designs allow for multiple configurations constructed with the same quality and strength as our cases.



472FLDDESKTA137
Single Field Desk



472FLDDESKDD137
Double Duty™ Field Desk

SPECIALTY PRODUCTS - FIELD DESKS | OFFICE SUPPORT

CATALOGUE NUMBER	COLLAPSED FORM	EXTENDED FORM	SPECIAL FEATURES*	COLOURS
472FLDDESKTA137	77.9 x 53.3 x 72.4 cm	156 x 72.4 x 72.4 cm	<ul style="list-style-type: none"> 1 Large work surface, chair, and drawers 6 Drawers: 2 shallow (padlock for extra security), 2 deep, 2 file sizes 1 Chair: load rated to 136 kg each Airtight and watertight 	
472FLDDESKDD137	86.3 x 63.2 x 72.4 cm	259.1 x 72.4 x 72.4 cm	<ul style="list-style-type: none"> 2 Large desk surfaces, with rolling casters 6 Drawers: 2 shallow (padlock for extra security), 2 deep, 2 file sizes 2 Casters 2 Chairs: Load rated to 136 kg each Airtight and watertight 	



IMTRLK-30001
Trunklocker



472FTLKL137
Footlocker



472MEDCHEST3182
Medchest 3



472MEDCHEST34D182
Medchest 4 drawer



472MEDCHEST38D182
Medchest 8 drawer

SPECIALTY PRODUCTS-MEDICAL CHEST | STORAGE LOCKERS

CATALOGUE NUMBER	EXTERIOR DIMENSIONS	INTERIOR DIMENSIONS	SPECIAL FEATURES*	COLOURS
IMTRLK-30001	92.2 x 47 x 49.8 cm	83.5 x 38.1 x 45.2 cm	<ul style="list-style-type: none"> Storage locker • Extra-deep storage cavity • Two press & pull latches • Injection moulded outer shell • Two organisation trays • Moulded-in stacking ribs • Water resistant 	
472FTLKL137	83.8 x 43.2 x 43.2 cm	73.6 x 35.5 x 38.1 cm	<ul style="list-style-type: none"> 2 wheels • 2 black trays • Spring loaded butterfly latches Airtight and watertight 	
472MEDCHEST3182	83.2 x 53 x 32 cm	75.5 x 45.4 x 27.4 cm	<ul style="list-style-type: none"> Storage chest • 2 wheels • Made from fire retardant material • Spring loaded butterfly latches 7.6 x 12.7cm Card holder • Airtight and watertight 	
472MEDCHEST34D182	83.2 x 53 x 32 cm	75.5 x 45.4 x 27.4 cm	<ul style="list-style-type: none"> Four-drawer case with full extension sliding drawers • 2 wheels • Spring loaded butterfly latches • Full-extension ball-bearing slides • Made from fire retardant material Airtight and watertight • Customisable divider system 	
472MEDCHEST38D182	83.2 x 53 x 32 cm	75.5 x 45.4 x 27.4 cm	<ul style="list-style-type: none"> Eight-drawer case with full extension sliding drawers • 2 wheels • Spring loaded butterfly latches Full-extension ball-bearing slides • Made from fire retardant material Airtight and watertight • Customisable divider system • One lockable drawer Removable stainless-steel work tray • Comfort Grip Handles 	

RACK MOUNT CASES

From the most delicate equipment to slightly more rugged electronics, Peli has a case with the perfect combination of shock, vibration protection and portability.



BlackBox-3U



BlackBox-4U



BlackBox-5U



BlackBox-7U



BlackBox-9U



BlackBox-11U



BlackBox-14U

RACK MOUNT CASES-BLACKBOX

CATALOGUE NUMBER	U-SIZE	LID INTERIOR DIM. (FRONT)	LID INTERIOR DIM. (BACK)	RACK L X W X H	EXTERIOR DIMENSIONS	COLOURS	STANDARD FEATURES
BLACKBOX-3U-M6	3U	5.6 cm	13.2 cm	61.0 x 48.3 x 13.3 cm	97.8 x 62.5 x 28.9 cm	■	<ul style="list-style-type: none"> Engineered racks provide a secure and mobile electronics enclosure up to 45.35 kg
BLACKBOX-4U-M6	4U	5.6 cm	13.2 cm	61.0 x 48.3 x 17.8 cm	97.8 x 62.5 x 33.3 cm	■	<ul style="list-style-type: none"> Shock mounts provide 5.1 cm of sway space to isolate equipment
BLACKBOX-5U-M6	5U	5.6 cm	13.2 cm	61.0 x 48.3 x 22.2 cm	97.8 x 62.5 x 37.8 cm	■	<ul style="list-style-type: none"> Moulded-in rib design provides secure stacking and interlock
BLACKBOX-7U-M6	7U	5.6 cm	13.2 cm	61.0 x 48.3 x 31.1 cm	97.8 x 62.5 x 46.7 cm	■	<ul style="list-style-type: none"> Patented wide-design Comfort Grip Handles make lifting easy
BLACKBOX-9U-M6	9U	5.6 cm	13.2 cm	61.0 x 48.3 x 40.0 cm	97.8 x 62.5 x 55.6 cm	■	<ul style="list-style-type: none"> Black hardware is long-lasting and fastens securely
BLACKBOX-11U-M6	11U	5.6 cm	13.2 cm	61.0 x 48.3 x 48.9 cm	97.8 x 62.5 x 64.5 cm	■	<ul style="list-style-type: none"> Lightweight and compact
BLACKBOX-14U-M6	14U	5.6 cm	13.2 cm	61.0 x 48.3 x 62.2 cm	97.8 x 62.5 x 77.7 cm	■	<ul style="list-style-type: none"> 2 wheels

MISCELLANEOUS

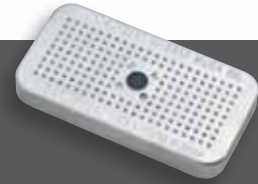

PELI™ DESICCANT (SILICA GEL)

CAT. NO. 1500D

Peli Desiccant Silica Gel “drinks” dampness, prevents condensation from trapped air when cases are opened in damp, high humidity climates.

- Fits all Peli Cases
- Size: 5.1 x 10.2 cm

QUICK MOUNTS (SET OF 4)

CAT. NO. 1507 | PELI™

- For mounting special equipment
- Fits all Storm Cases
- Colour: Black

TSA LOCK

CAT. NO. 1506TSA

- Special TSA accepted lock
- TSA personnel can safely lock and unlock
- You can set hundreds of combinations
- Fits all Peli Cases

SEE THE FULL LINE OF PRODUCTS AT **PELI.COM**

OR

DOWNLOAD OUR NEW DIGITAL CATALOGUE **PELICATALOGUE.COM** AVAILABLE IN 17 LANGUAGES!

GLOBAL LOCATIONS

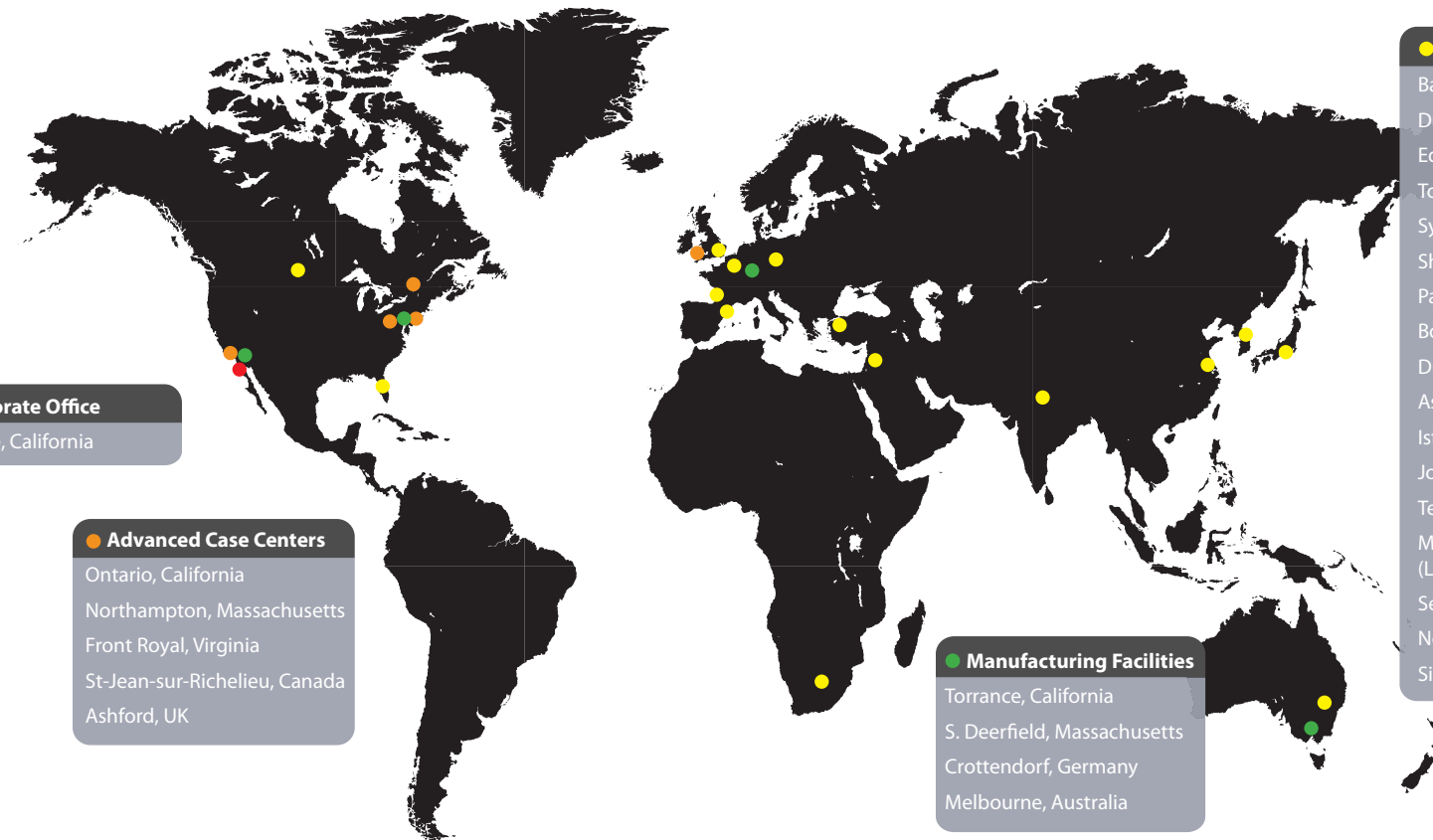

International Sales Offices

- Barcelona, Spain
- Dusseldorf, Germany
- Edmonton, Canada
- Tokyo, Japan
- Sydney, Australia
- Shanghai, China
- Paris, France
- Bourg en Bresse, France
- Dubai, UAE
- Ashford, UK
- Istanbul, Turkey
- Johannesburg, South Africa
- Tel Aviv, Israel
- Miami, Florida (Latin America)
- Seoul, S. Korea
- New Delhi, India
- Singapore

Corporate Office

Torrance, California

Advanced Case Centers

- Ontario, California
- Northampton, Massachusetts
- Front Royal, Virginia
- St-Jean-sur-Richelieu, Canada
- Ashford, UK

Manufacturing Facilities

- Torrance, California
- S. Deerfield, Massachusetts
- Crottendorf, Germany
- Melbourne, Australia



PELI TOUGH LIGHTING TOOLS

- Safety approved lights for hazardous areas (ATEX approved models)
- Tactical lights for military and law enforcement
- Specialised lights for fire and rescue operations
- Submersible lights for diving
- Headlamps



PELI LED AREA LIGHTING

- Up to 100 hours of light
- Lightweight
- Battery powered
- Breakthrough LED technology
- Portable, rechargeable, and completely collapsible
- Designed for Heavy Duty Jobs
- Safe, Noise Free, Fume Free
- Spot Lighting, Flood Lighting, NVG Lighting
- New Intelligent Control Switch Technology optimises power output vs burntime (9460, 946RS, 9470 & 9470RS)



PELI-HARDIGG™ SINGLE LID CASES

- Rotational Moulding Technology
- Recessed hardware
- Comfort Grip Handles
- Available airtight/watertight designs
- Over 500 sizes
- Built-in skid runners option available on select models
- Mobile Military solutions for Medical, Information Technology, Office, Armory, and Transport Logistics
- Reinforced corners and edges for impact protection



PELI-HARDIGG™ RACK MOUNT CASES

- Over 140 models from 3U-26U for rack depths of 48-83 cm
- Rotational Moulding Technology for secure server transport
- Controls impact forces from 15 Gs to 120 Gs
- Shock mounts isolate vibration and impacts
- Designed to meet ANSI/EIA-310C for universal rack mounting hole pattern
- Removable rack systems for use in the field (select models)



PELI-HARDIGG™ ADVANCED CASE SOLUTIONS™

- Mission Critical Custom Cases
- Unlimited bespoke case solutions
- Project evaluation
- Prototype, first articles, and testing
- Complete design and engineered custom solutions
- Manufacturing and Integration

